

# STANDARD ALPHABETS

FOR HIGHWAY SIGNS

APPROVED BY

AMERICAN ASSOCIATION OF STATE HIGHWAY OFFICIALS

INSTITUTE OF TRAFFIC ENGINEERS

NATIONAL COMMITTEE ON UNIFORM TRAFFIC  
LAWS AND ORDINANCES

DEPARTMENT OF COMMERCE  
BUREAU OF PUBLIC ROADS

HC-2

U.S. GOVERNMENT PRINTING OFFICE

WASHINGTON, D. C. 20540

## STANDARD ALPHABETS FOR HIGHWAY SIGNS

These Standard Alphabets for Highway Signs have been designed by the U. S. Public Roads Administration at the request of the Joint Committee on Uniform Traffic Control Devices, and have been approved by that committee and its constituent agencies, the American Association of State Highway Officials, the Institute of Traffic Engineers, and the National Conference on Street and Highway Safety. They are intended to replace the old "Joint Board" alphabets published nearly 20 years ago when highway signs were first standardized on a national basis. The new "rounded" style has a more pleasing appearance than the old, and extensive tests have shown it to be consistently more legible.

It is not expected that the new letters and numerals will at once displace the old. Existing highway signs, it is assumed, will not ordinarily be scrapped until the end of their normal life, though there may be desirable exceptions as, for example, where two signs are mounted so closely adjacent that a contrast in letter style would be objectionable.

In individual widths, the new letters and numerals closely approximate the old, so that they are easily interchangeable with the old in standard sign designs.

Most highway departments and sign manufacturers will find it desirable to make up a set of templates of fiber or light metal to simplify the laying out of signs. The letters and numerals may be reproduced in any desired size by following the table of dimensions carried on each sheet of the drawings (or by adjusting dimensions proportionally for sizes not shown), or by a photographic enlargement or reduction of drawings of any size. It is not recommended, however, that photographic enlargements be made from the small printed drawings, which will be found to vary slightly in dimensional accuracy.

Although the new letters and numerals are not quite as simply designed as the more mechanical, rectangular characters of the old Joint Board standards, they are not difficult to reproduce on the drawing board. To facilitate the laying out of different sizes, the detailed dimensions are shown only in a letter code referring to the tabulation at the bottom of each sheet. Tangents, major arcs, and certain indicated control points are laid down first, followed by the connecting arcs of shorter radius. Two circumstances must be noted:

1. Under certain conditions the radii of connecting arcs cannot be given precisely. In these cases there is only one possible arc that can fit accurately to all controlling points. The dimension given on the drawing is a close approximation, but the draftsman may have to make a slight adjustment to achieve a perfect fit. This applies especially to the large letters, since the dimensions in the tables were generally derived from measurements on smaller drawings.

2. For similar reasons, it is not practical to show the exact centers of all arcs. Centers are invariably indicated for the controlling arcs. For others the draftsman must set his compasses and find the center by experiment.

The stroke-width of the letters and numerals is uniform throughout any size and series of alphabet, except where otherwise definitely indicated.

All characters having an arc at top or bottom are extended slightly above or below the line of the other letters. This is in accord with accepted practice for rounded letters.

If the design of any particular letter or numeral in a given size is incompatible with any manufacturing process, necessary modifications may be made within reasonable limits. For example, the height or length of a horizontal member may have to be adjusted slightly to permit a satisfactory arrangement of reflector buttons, or to provide necessary clearance for embossing dies.

December 1945

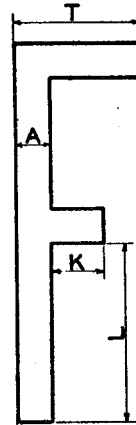
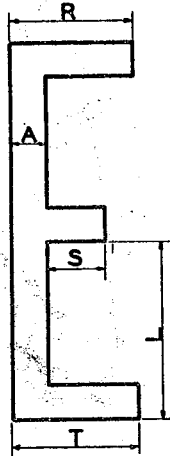
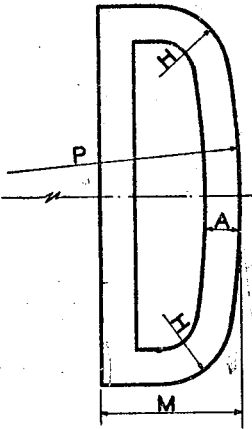
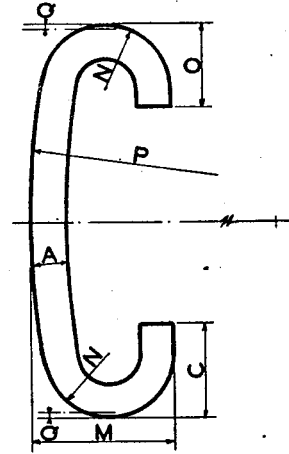
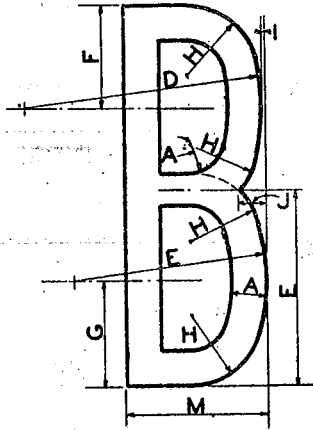
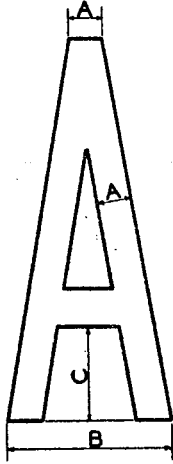

## SERIES A LETTERS

HEIGHT (INCHES)	DIMENSIONS (INCHES)																			
	A	B	C	D	E	F	G	H	I	J	K	L	M	N	O	P	Q	R	S	T
2	$\frac{7}{16}$	$\frac{7}{8}$	$\frac{1}{2}$	$1\frac{1}{4}$	$1\frac{1}{32}$	$1\frac{17}{32}$	$\frac{9}{16}$	$\frac{3}{8}$	$\frac{1}{64}$	$\frac{9}{64}$	$\frac{9}{32}$	$1\frac{13}{16}$	$\frac{7}{8}$	$1\frac{11}{32}$	$\frac{7}{16}$	$4\frac{1}{2}$	$\frac{1}{32}$	$\frac{31}{64}$	$\frac{5}{16}$	$\frac{23}{64}$
3	$\frac{9}{32}$	$1\frac{1}{16}$	$\frac{3}{4}$	$1\frac{7}{8}$	$1\frac{27}{64}$	$1\frac{51}{64}$	$\frac{37}{32}$	$\frac{9}{16}$	$\frac{1}{64}$	$\frac{9}{64}$	$\frac{27}{64}$	$1\frac{13}{32}$	$1\frac{1}{8}$	$1\frac{33}{64}$	$\frac{31}{32}$	$6\frac{1}{4}$	$\frac{3}{64}$	$\frac{63}{64}$	$1\frac{15}{32}$	1
4	$\frac{3}{8}$	$1\frac{3}{4}$	1	$2\frac{1}{2}$	$2\frac{1}{16}$	$1\frac{1}{16}$	$1\frac{1}{8}$	$\frac{3}{8}$	$\frac{1}{32}$	$\frac{3}{32}$	$\frac{9}{16}$	$1\frac{1}{8}$	$1\frac{1}{2}$	$1\frac{1}{16}$	$\frac{9}{8}$	9	$\frac{1}{16}$	$1\frac{1}{8}$	$\frac{5}{8}$	$1\frac{1}{32}$
5	$1\frac{13}{32}$	$2\frac{7}{16}$	$1\frac{1}{4}$	$3\frac{1}{8}$	$2\frac{27}{64}$	$1\frac{21}{64}$	$1\frac{13}{32}$	$1\frac{13}{16}$	$\frac{1}{32}$	$\frac{1}{32}$	$\frac{23}{64}$	$2\frac{1}{2}$	$1\frac{7}{8}$	$2\frac{1}{8}$	$1\frac{3}{32}$	$11\frac{1}{2}$	$\frac{5}{64}$	$1\frac{21}{64}$	$\frac{53}{64}$	$1\frac{43}{64}$
6	$\frac{9}{16}$	$2\frac{5}{8}$	$1\frac{1}{2}$	$3\frac{3}{4}$	$3\frac{3}{32}$	$1\frac{19}{32}$	$1\frac{1}{16}$	$1\frac{1}{8}$	$\frac{1}{64}$	$\frac{27}{64}$	$\frac{27}{32}$	$2\frac{1}{16}$	$2\frac{1}{4}$	$1\frac{1}{32}$	$1\frac{1}{16}$	$13\frac{1}{2}$	$\frac{3}{32}$	$1\frac{31}{64}$	$1\frac{1}{8}$	$2\frac{1}{64}$
7	$\frac{11}{32}$	$3\frac{1}{16}$	$1\frac{3}{4}$	$4\frac{3}{8}$	$3\frac{23}{64}$	$1\frac{25}{64}$	$1\frac{31}{32}$	$1\frac{1}{16}$	$\frac{3}{64}$	$\frac{21}{64}$	$\frac{53}{64}$	$3\frac{9}{32}$	$2\frac{5}{8}$	$1\frac{13}{64}$	$1\frac{17}{32}$	$15\frac{3}{4}$	$\frac{7}{64}$	$2\frac{13}{64}$	$1\frac{1}{32}$	$2\frac{1}{32}$
8	$\frac{5}{8}$	$3\frac{1}{2}$	2	5	$4\frac{1}{8}$	$2\frac{1}{8}$	2 $\frac{1}{2}$	$1\frac{1}{2}$	$\frac{1}{16}$	$\frac{9}{16}$	$1\frac{1}{8}$	$3\frac{3}{8}$	3	$1\frac{1}{8}$	$1\frac{3}{4}$	18	$\frac{1}{8}$	$2\frac{5}{8}$	$1\frac{1}{4}$	$2\frac{1}{16}$
12	$1\frac{1}{8}$	$5\frac{1}{4}$	3	$7\frac{1}{2}$	$6\frac{3}{16}$	$3\frac{3}{16}$	$3\frac{3}{8}$	$2\frac{1}{4}$	$\frac{3}{32}$	$\frac{27}{32}$	$1\frac{1}{16}$	$5\frac{5}{8}$	$4\frac{1}{2}$	$2\frac{1}{16}$	$2\frac{5}{8}$	27	$\frac{3}{16}$	$3\frac{15}{16}$	$1\frac{7}{8}$	$4\frac{1}{32}$
18	$1\frac{1}{16}$	$7\frac{7}{8}$	$4\frac{1}{2}$	$11\frac{1}{4}$	$9\frac{9}{32}$	$4\frac{3}{32}$	$5\frac{1}{16}$	$3\frac{3}{8}$	$\frac{1}{8}$	$1\frac{1}{4}$	$2\frac{17}{32}$	$7\frac{1}{16}$	$6\frac{1}{4}$	$3\frac{3}{32}$	$3\frac{1}{16}$	$40\frac{1}{2}$	$\frac{5}{32}$	$5\frac{23}{32}$	$2\frac{1}{8}$	$6\frac{1}{16}$

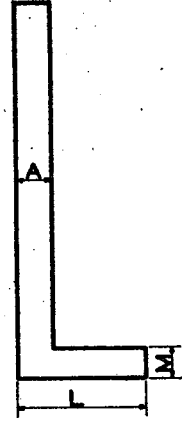
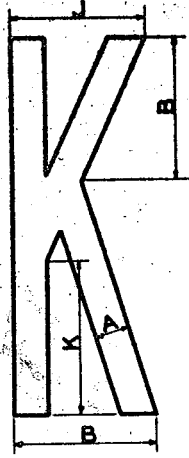
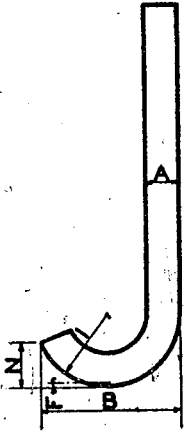
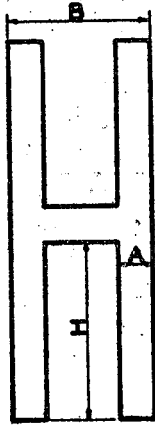
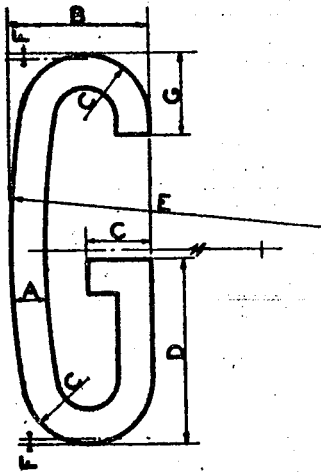

### SERIES A LETTERS

HEIGHT (INCHES)	DIMENSIONS (INCHES)													
	A	B	C	D	E	F	G	H	I	J	K	L	M	N
2	$\frac{7}{16}$	$\frac{7}{8}$	$\frac{3}{32}$	$\frac{3}{32}$	$4\frac{1}{2}$	$\frac{1}{16}$	$\frac{7}{16}$	$\frac{1}{16}$	$\frac{3}{32}$	$\frac{3}{32}$	$\frac{1}{16}$	$\frac{3}{32}$	$\frac{3}{32}$	$\frac{1}{4}$
3	$\frac{9}{32}$	$1\frac{1}{8}$	$\frac{3}{32}$	$1\frac{3}{32}$	$6\frac{3}{4}$	$\frac{1}{16}$	$\frac{7}{16}$	$1\frac{1}{32}$	$\frac{3}{32}$	$1\frac{1}{16}$	$1\frac{1}{32}$	1	$\frac{1}{4}$	$\frac{3}{8}$
4	$\frac{3}{8}$	$1\frac{1}{2}$	$\frac{1}{16}$	$1\frac{1}{16}$	9	$\frac{1}{16}$	$\frac{7}{8}$	$1\frac{1}{8}$	$\frac{3}{16}$	$1\frac{1}{16}$	$1\frac{1}{8}$	$1\frac{1}{32}$	$\frac{3}{16}$	$\frac{1}{2}$
5	$\frac{1}{2}$	$1\frac{7}{8}$	$\frac{3}{32}$	$2\frac{27}{32}$	$11\frac{1}{4}$	$\frac{1}{16}$	$1\frac{3}{32}$	$2\frac{1}{32}$	$\frac{3}{16}$	$1\frac{3}{16}$	$2\frac{1}{32}$	$1\frac{3}{32}$	$\frac{3}{8}$	$\frac{3}{8}$
6	$\frac{5}{16}$	$2\frac{1}{4}$	$1\frac{1}{32}$	$2\frac{29}{32}$	$13\frac{1}{2}$	$\frac{1}{16}$	$1\frac{1}{16}$	$2\frac{1}{16}$	$1\frac{1}{16}$	$2\frac{1}{32}$	$2\frac{1}{16}$	$2\frac{1}{16}$	$\frac{3}{16}$	$\frac{3}{4}$
7	$\frac{3}{4}$	$2\frac{3}{8}$	$1\frac{1}{16}$	$3\frac{27}{32}$	$15\frac{1}{2}$	$\frac{1}{16}$	$1\frac{1}{32}$	$3\frac{3}{32}$	$1\frac{1}{16}$	$2\frac{27}{32}$	$2\frac{1}{32}$	$2\frac{1}{32}$	$\frac{3}{8}$	$\frac{7}{8}$
8	$\frac{7}{8}$	3	$1\frac{1}{8}$	$3\frac{7}{8}$	18	$\frac{1}{8}$	$1\frac{1}{4}$	$3\frac{1}{4}$	$1\frac{1}{8}$	$2\frac{1}{4}$	$3\frac{1}{4}$	$2\frac{1}{16}$	$\frac{1}{2}$	1
12	$1\frac{1}{8}$	$4\frac{1}{2}$	$2\frac{1}{16}$	$5\frac{1}{16}$	27	$\frac{1}{8}$	$2\frac{1}{8}$	$5\frac{1}{8}$	$2\frac{1}{4}$	$4\frac{1}{8}$	$4\frac{1}{8}$	$4\frac{1}{2}$	$1\frac{1}{2}$	$1\frac{1}{2}$
18	$1\frac{1}{16}$	$6\frac{3}{4}$	$3\frac{3}{32}$	$8\frac{27}{32}$	$40\frac{1}{2}$	$\frac{1}{8}$	$3\frac{1}{16}$	$8\frac{1}{16}$	$3\frac{3}{16}$	$6\frac{1}{16}$	$7\frac{1}{8}$	$6\frac{1}{8}$	$1\frac{1}{8}$	$2\frac{1}{4}$

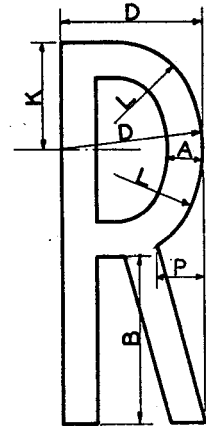
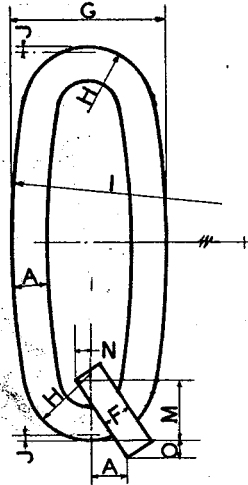
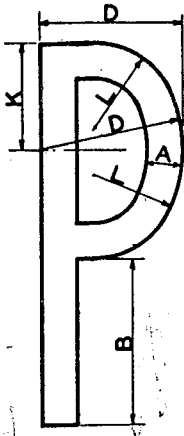
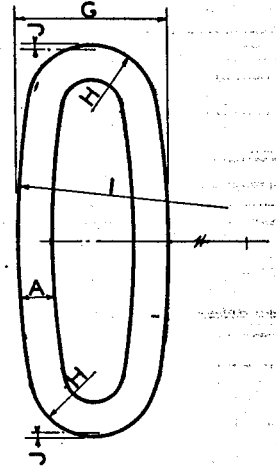
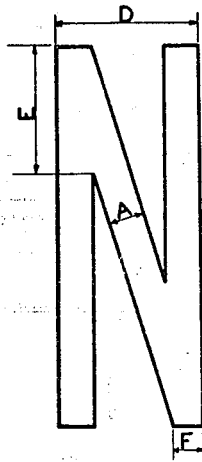
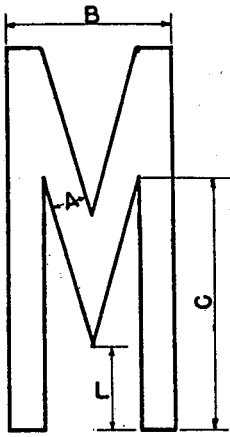

### SERIES A LETTERS

HEIGHT (INCHES)	DIMENSIONS (INCHES)															
	A	B	C	D	E	F	G	H	I	J	K	L	M	N	O	P
2	$\frac{3}{16}$	$\frac{7}{8}$	$\frac{15}{16}$	$\frac{3}{4}$	$\frac{21}{32}$	$\frac{5}{32}$	$\frac{13}{16}$	$\frac{11}{32}$	$4\frac{1}{2}$	$\frac{1}{32}$	$\frac{9}{16}$	$\frac{7}{16}$	$\frac{5}{16}$	$\frac{5}{64}$	$\frac{3}{32}$	$\frac{1}{4}$
3	$\frac{3}{32}$	$\frac{15}{16}$	$\frac{31}{32}$	$1\frac{1}{8}$	$\frac{63}{64}$	$\frac{15}{64}$	$\frac{17}{32}$	$\frac{33}{64}$	$6\frac{3}{4}$	$\frac{3}{64}$	$\frac{27}{32}$	$\frac{21}{32}$	$\frac{15}{32}$	$\frac{7}{64}$	$\frac{9}{64}$	$\frac{3}{8}$
4	$\frac{3}{8}$	$1\frac{3}{4}$	$2\frac{5}{8}$	$1\frac{1}{2}$	$1\frac{5}{16}$	$\frac{5}{16}$	$1\frac{5}{8}$	$\frac{11}{16}$	9	$\frac{1}{16}$	$1\frac{1}{8}$	$\frac{7}{8}$	$\frac{5}{8}$	$\frac{5}{32}$	$\frac{3}{16}$	$\frac{1}{2}$
5	$\frac{15}{32}$	$2\frac{3}{16}$	$3\frac{9}{32}$	$1\frac{7}{8}$	$1\frac{41}{64}$	$\frac{25}{64}$	$2\frac{1}{32}$	$\frac{55}{64}$	$11\frac{1}{4}$	$\frac{5}{64}$	$1\frac{13}{32}$	$\frac{13}{32}$	$\frac{23}{32}$	$\frac{3}{16}$	$\frac{15}{64}$	$\frac{5}{8}$
6	$\frac{3}{16}$	$2\frac{5}{8}$	$3\frac{15}{16}$	$2\frac{1}{4}$	$1\frac{31}{32}$	$\frac{15}{32}$	$2\frac{7}{16}$	$1\frac{1}{32}$	$13\frac{1}{2}$	$\frac{3}{32}$	$1\frac{11}{16}$	$\frac{15}{16}$	$\frac{15}{16}$	$\frac{15}{64}$	$\frac{9}{32}$	$\frac{3}{4}$
7	$\frac{21}{32}$	$3\frac{1}{16}$	$4\frac{19}{32}$	$2\frac{5}{8}$	$2\frac{19}{64}$	$\frac{35}{64}$	$2\frac{27}{32}$	$1\frac{13}{64}$	$15\frac{3}{4}$	$\frac{7}{64}$	$1\frac{31}{32}$	$1\frac{17}{32}$	$1\frac{3}{32}$	$\frac{17}{64}$	$\frac{21}{64}$	$\frac{7}{8}$
8	$\frac{3}{4}$	$3\frac{1}{2}$	$5\frac{1}{4}$	3	$2\frac{23}{8}$	$\frac{5}{8}$	$3\frac{1}{4}$	$1\frac{3}{8}$	18	$\frac{1}{8}$	$2\frac{1}{4}$	$1\frac{3}{4}$	$1\frac{1}{4}$	$\frac{5}{16}$	$\frac{3}{8}$	1
12	$1\frac{1}{8}$	$5\frac{1}{4}$	$7\frac{7}{8}$	$4\frac{1}{2}$	$3\frac{13}{16}$	$\frac{15}{16}$	$4\frac{1}{8}$	$2\frac{1}{16}$	27	$\frac{3}{16}$	$3\frac{3}{8}$	$2\frac{5}{8}$	$1\frac{7}{8}$	$\frac{15}{32}$	$\frac{9}{16}$	$1\frac{1}{2}$
18	$1\frac{11}{16}$	$7\frac{7}{8}$	$11\frac{13}{16}$	$6\frac{3}{4}$	$5\frac{29}{32}$	$\frac{13}{32}$	$7\frac{5}{16}$	$3\frac{3}{32}$	$40\frac{1}{2}$	$\frac{9}{32}$	$5\frac{1}{16}$	$3\frac{15}{16}$	$2\frac{13}{16}$	$\frac{11}{16}$	$\frac{27}{32}$	$2\frac{1}{4}$

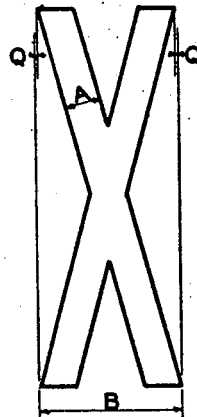
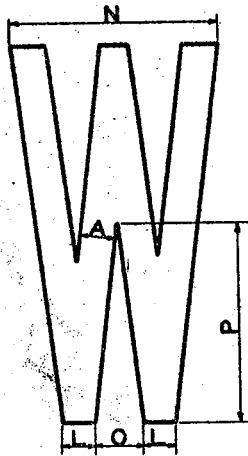
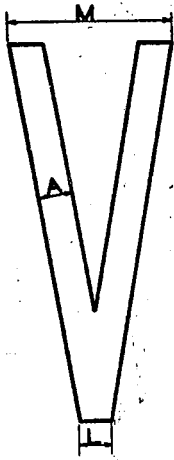
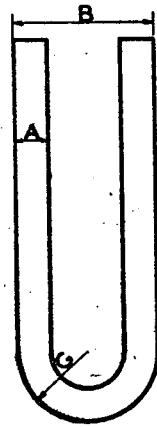
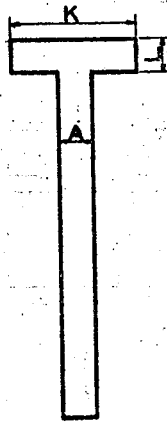
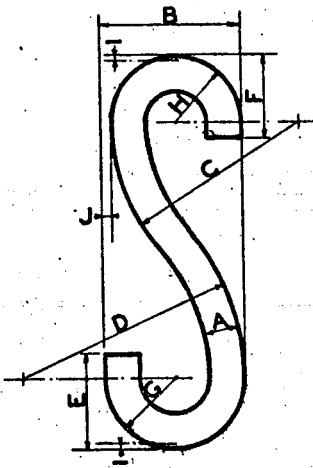

### SERIES A LETTERS

HEIGHT (INCHES)	DIMENSIONS (INCHES)																
	A	B	C	D	E	F	G	H	I	J	K	L	M	N	O	P	Q
2	$\frac{1}{16}$	$\frac{3}{4}$	1	$\frac{1}{16}$	$\frac{1}{2}$	$\frac{7}{16}$	$\frac{3}{8}$	$\frac{11}{32}$	$\frac{1}{2}$	$\frac{3}{8}$	$\frac{11}{32}$	$\frac{1}{4}$	$\frac{7}{8}$	$\frac{1}{32}$	$\frac{1}{16}$	$\frac{1}{8}$	$\frac{1}{4}$
3	$\frac{3}{32}$	$1\frac{1}{8}$	$1\frac{1}{2}$	$1\frac{1}{32}$	$\frac{3}{4}$	$\frac{9}{16}$	$\frac{1}{2}$	$\frac{17}{32}$	$\frac{3}{4}$	$\frac{1}{2}$	1	$\frac{1}{4}$	$1\frac{1}{16}$	$1\frac{1}{2}$	$\frac{3}{8}$	$1\frac{1}{8}$	$\frac{1}{4}$
4	$\frac{1}{8}$	$1\frac{1}{2}$	2	$2\frac{3}{8}$	1	$\frac{7}{8}$	$\frac{3}{4}$	$\frac{11}{16}$	$\frac{1}{2}$	$\frac{3}{4}$	$1\frac{1}{2}$	$\frac{1}{2}$	$1\frac{3}{4}$	$2\frac{1}{8}$	$\frac{1}{2}$	$2\frac{1}{8}$	$\frac{1}{2}$
5	$\frac{15}{32}$	$1\frac{7}{8}$	$2\frac{1}{2}$	$2\frac{31}{32}$	$1\frac{1}{4}$	$1\frac{1}{32}$	$1\frac{1}{8}$	$\frac{15}{16}$	$\frac{7}{8}$	$\frac{1}{2}$	$1\frac{1}{4}$	$\frac{27}{64}$	$2\frac{1}{16}$	$2\frac{17}{64}$	$\frac{3}{8}$	$2\frac{11}{32}$	$\frac{1}{2}$
6	$\frac{9}{16}$	$2\frac{1}{4}$	3	$3\frac{1}{16}$	$1\frac{1}{2}$	$1\frac{1}{16}$	$1\frac{1}{8}$	$1\frac{1}{8}$	$\frac{3}{2}$	$\frac{3}{4}$	$2\frac{1}{4}$	$\frac{33}{64}$	$2\frac{1}{8}$	$3\frac{1}{32}$	$\frac{3}{4}$	$3\frac{1}{16}$	$\frac{3}{4}$
7	$\frac{31}{32}$	$2\frac{5}{8}$	$3\frac{1}{2}$	$4\frac{1}{32}$	$1\frac{3}{4}$	$1\frac{1}{32}$	$1\frac{1}{16}$	$1\frac{15}{64}$	$\frac{7}{8}$	$\frac{1}{2}$	$2\frac{1}{2}$	$\frac{19}{32}$	$3\frac{1}{16}$	$3\frac{13}{64}$	$\frac{7}{8}$	$3\frac{1}{32}$	$\frac{3}{4}$
8	$\frac{3}{4}$	3	4	$4\frac{1}{4}$	2	$1\frac{3}{4}$	$1\frac{1}{2}$	$1\frac{1}{32}$	$\frac{1}{2}$	$\frac{1}{2}$	$2\frac{1}{16}$	$\frac{1}{16}$	$3\frac{1}{2}$	$4\frac{1}{8}$	1	$4\frac{1}{4}$	$\frac{1}{2}$
12	$1\frac{1}{8}$	$4\frac{1}{2}$	6	$7\frac{1}{8}$	3	$2\frac{3}{8}$	$2\frac{1}{4}$	$2\frac{1}{4}$	$\frac{1}{2}$	$\frac{1}{2}$	$4\frac{1}{2}$	$1\frac{1}{2}$	$5\frac{1}{4}$	$6\frac{1}{16}$	$1\frac{1}{2}$	$6\frac{3}{8}$	$\frac{3}{2}$
18	$1\frac{1}{16}$	$6\frac{3}{4}$	9	$10\frac{1}{16}$	$4\frac{1}{2}$	$3\frac{1}{16}$	$3\frac{3}{8}$	$3\frac{1}{32}$	$\frac{3}{2}$	$\frac{7}{16}$	$6\frac{1}{16}$	$1\frac{1}{16}$	$7\frac{1}{8}$	$8\frac{1}{32}$	2	$9\frac{1}{16}$	$\frac{1}{2}$

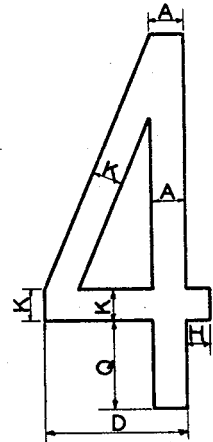
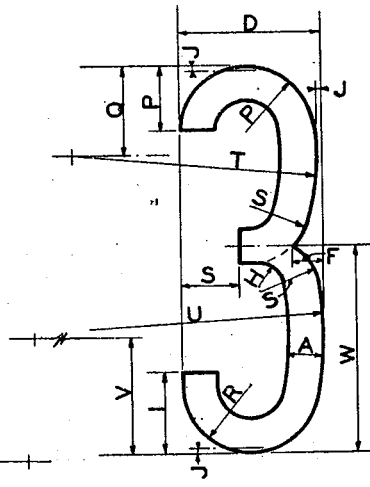
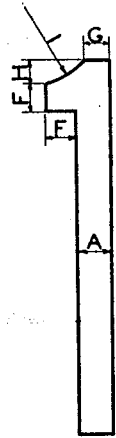
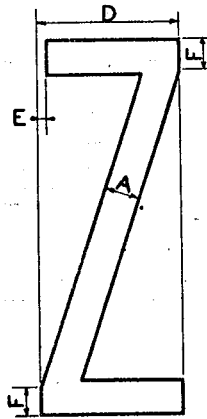
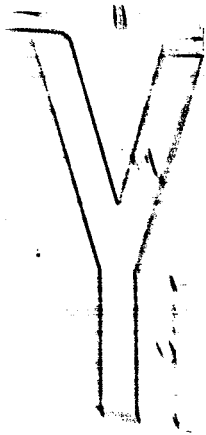

## SERIES A LETTERS AND NUMERALS

		DIMENSIONS (INCHES)																									
		B	C	D	E	F	G	H	I	J	K	L	M	N	O	P	Q	R	S	T	U	V	W				
1/8 3/16 1/4 5/16 3/8 1/2 5/8 3/4 7/8 1	1/8	5/32	3/8	1/4	5/16	3/8	1/2	3/4	1	1 1/8	1 1/4	1 1/2	1 3/4	2	2 1/8	2 1/4	2 1/2	2 3/4	3	3 1/8	3 1/4	3 1/2	3 3/4	4			
	3/16	11/64	1/8	1/16	15/64	13/64	1/8	21/32	3/8	1/2	3/4	1	1 1/8	1 1/4	1 1/2	1 3/4	2	2 1/8	2 1/4	2 1/2	2 3/4	3	3 1/8	3 1/4			
	1/4	1/8	1/16	15/64	13/64	1/8	21/32	3/8	1/2	3/4	1	1 1/8	1 1/4	1 1/2	1 3/4	2	2 1/8	2 1/4	2 1/2	2 3/4	3	3 1/8	3 1/4	3 1/2			
	5/16	17/64	7/64	25/64	11/32	5/16	1 1/8	1 1/4	1 1/2	1 3/4	2	2 1/8	2 1/4	2 1/2	2 3/4	3	3 1/8	3 1/4	3 1/2	3 3/4	4	4 1/8	4 1/4	4 1/2			
	3/8	2 1/32	2 1/4	2 3/8	2 1/2	2 5/8	2 3/4	3	3 1/8	3 1/4	3 1/2	3 3/4	4	4 1/8	4 1/4	4 1/2	4 3/4	5	5 1/8	5 1/4	5 1/2	5 3/4	6	6 1/8	6 1/4		
	1/2	2 27/64	2 5/8	2 5/4	2 25/64	2 31/64	2 7/16	2 11/32	2 7/8	2 13/16	2 3/4	2 19/16	2 15/8	2 51/32	2 71/32	2 7/8	2 11/4	2 11/2	2 1 1/4	2 1 1/2	2 1 3/4	2 1 7/8	2 1 3/4	2 1 7/8	2 1 3/4		
	5/8	3 1/8	3	3 1/16	3 1/8	3 1/8	3 1/2	3 1/4	3 1/2	3 3/4	3 1/2	3 1/2	3 1/2	3 1/2	3 1/2	3 1/2	3 1/2	3 1/2	3 1/2	3 1/2	3 1/2	3 1/2	3 1/2	3 1/2	3 1/2		
	3/4	4 1/16	4 1/2	4 3/32	4 13/64	4 31/64	4 7/16	4 11/32	4 7/8	4 13/16	4 3/2	4 13/16	4 15/8	4 51/32	4 71/32	4 7/8	4 11/4	4 1 1/2	4 1 1/4	4 1 1/2	4 1 3/4	4 1 7/8	4 1 3/4	4 1 7/8	4 1 3/4		
	7/8	4 11/16	4 1/2	4 3/32	4 13/64	4 31/64	4 7/16	4 11/32	4 7/8	4 13/16	4 3/2	4 13/16	4 15/8	4 51/32	4 71/32	4 7/8	4 11/4	4 1 1/2	4 1 1/4	4 1 1/2	4 1 3/4	4 1 7/8	4 1 3/4	4 1 7/8	4 1 3/4		
	1	5 1/8	5 1/4	5 1/8	5 1/8	5 1/8	5 1/2	5 1/4	5 1/2	5 3/4	5 1/2	5 1/2	5 1/2	5 1/2	5 1/2	5 1/2	5 1/2	5 1/2	5 1/2	5 1/2	5 1/2	5 1/2	5 1/2	5 1/2	5 1/2		



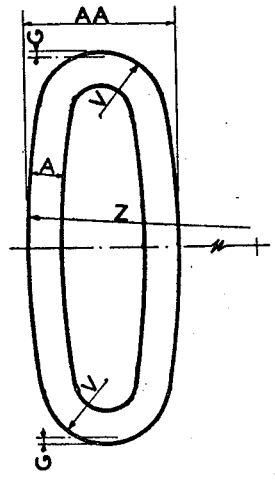
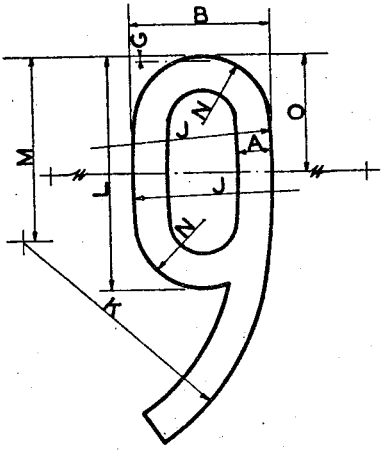
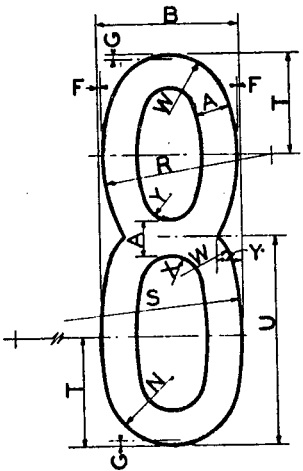
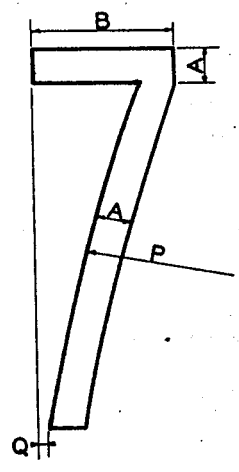
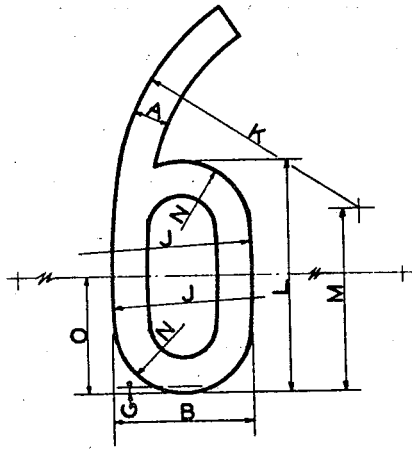
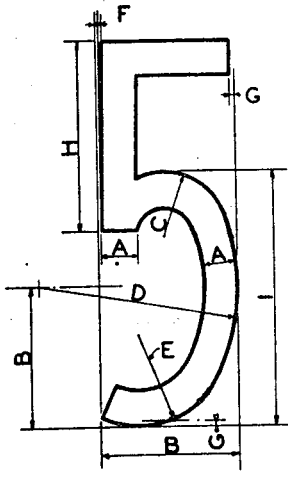

### SERIES A NUMERALS

HEIGHT (INCHES)	DIMENSIONS (INCHES)																										
	A	B	C	D	E	F	G	H	I	J	K	L	M	N	O	P	Q	R	S	T	U	V	W	X	Y	Z	AA
2	3/16	3/4	3/32	1/8	3/64	6/4	3/2	1	11/32	3/4	1/32	1/2	3/32	2/32	2/32	9	1/6	3/32	1/16	17/32	1/32	2/4	5/16	2/64	1/8	4 1/2	1/16
3	3/32	1/8	3/64	1/32	3/32	6/4	3/4	1 1/2	2 1/64	5/8	1 5/8	1 5/8	1 5/8	1/2	3/32	13 1/2	3/32	1 2/32	2 1/2	3/4	1 1/4	2/4	1/32	1/32	1/8	6 1/2	1/32
4	3/8	1 1/2	1/16	2 1/8	3/32	3/2	1/6	2	2 1/16	7 1/2	2 1/8	2 1/6	1 1/8	3/32	1 1/2	18	1/8	1 1/8	3 3/8	1/16	2 1/8	3/32	5/8	3/32	1/4	9	1/8
5	1/32	1/8	3/64	2 3/4	1 1/4	3/2	3/64	2 1/2	3 3/8	9 3/8	3 3/8	3 3/8	2 1/2	3/32	1 1/2	22 1/2	5/32	2 1/4	4 1/2	1 1/4	2 1/4	1/16	3/32	1/32	1 1/4	11 1/4	2 1/32
6	3/16	2 1/4	1/32	3 3/8	1 1/4	3/64	3/32	3	4 1/32	1 1/4	3 3/8	3 3/8	2 3/8	3/64	1 1/2	27	3/16	2 3/8	5 1/16	1 1/8	3 3/8	3/32	3/16	1/16	27/64	3/8	13 1/2
7	2 1/32	2 3/8	1 1/4	3 3/8	1 1/8	3/64	7/64	3 1/2	4 1/32	1 3/8	4 1/64	4 1/64	3 3/8	1 1/4	2 1/8	3 1/2	7/32	3 1/4	5 3/8	1 1/4	3 3/8	1 1/4	1/16	1/4	3/16	1 1/2	18
8	3/4	3	1 3/8	4 1/4	1 1/8	1/16	1/8	4	5 3/8	15	5 1/8	4 7/8	3 7/8	1 1/16	2 1/8	36	1/4	3 3/8	6 1/4	2 1/8	4 3/8	1 1/4	1/16	1/4	3/16	1/2	18
12	1/8	4 1/2	2 1/16	6 3/8	2 3/32	3/32	3/16	6	8 1/16	22 1/2	7 1/16	7 1/8	5 1/16	2 3/32	3 1/32	54	3/8	5 7/16	10 1/8	3 1/16	6 1/16	3 1/32	1 1/8	27/32	3/4	27	
18	1 1/16	6 1/2	3 3/2	9 3/16	4 3/8	1/8	3/32	9	12 3/32	33 3/4	11 1/32	10 1/32	8 3/32	3 1/4	5 1/2	81	3/16	8 5/32	15 3/16	4 3/32	9 3/32	2 1/8	2 1/16	1 1/4	1 1/8	40 1/2	

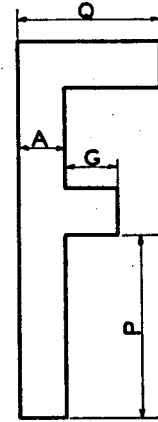
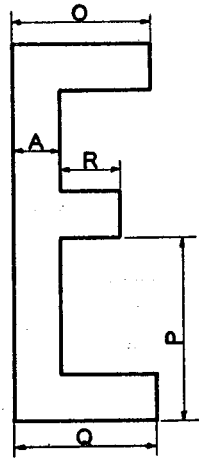
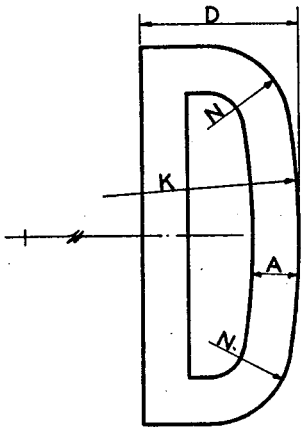
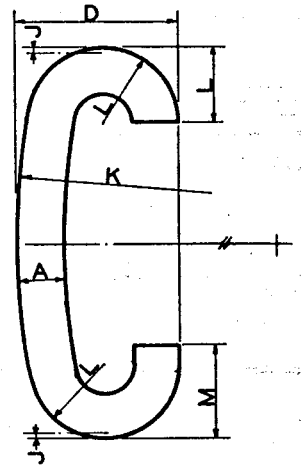
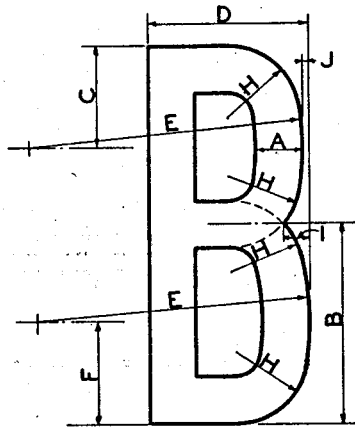
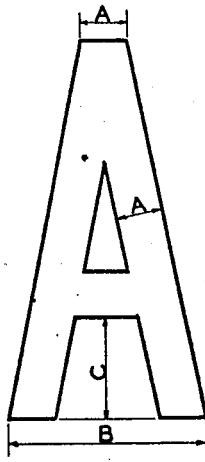

## SERIES B LETTERS

HEIGHT (INCHES)	DIMENSIONS (INCHES)																	
	A	B	C	D	E	F	G	H	I	J	K	L	M	N	O	P	Q	R
2	$\frac{1}{4}$	$\frac{1}{16}$	$\frac{17}{32}$	$\frac{27}{32}$	$\frac{17}{16}$	$\frac{35}{64}$	$\frac{9}{32}$	$\frac{3}{8}$	$\frac{1}{8}$	$\frac{3}{32}$	4	$\frac{25}{64}$	$\frac{1}{2}$	$\frac{7}{16}$	$\frac{47}{64}$	$\frac{31}{32}$	$\frac{3}{4}$	$\frac{5}{16}$
3	$\frac{3}{8}$	$\frac{19}{32}$	$\frac{51}{64}$	$\frac{17}{16}$	$\frac{25}{32}$	$\frac{13}{16}$	$\frac{27}{64}$	$\frac{9}{16}$	$\frac{3}{16}$	$\frac{3}{64}$	6	$\frac{37}{64}$	$\frac{3}{4}$	$\frac{21}{32}$	$\frac{13}{16}$	$\frac{129}{64}$	$\frac{11}{8}$	$\frac{15}{32}$
4	$\frac{1}{2}$	$\frac{2}{8}$	$\frac{1}{16}$	$\frac{11}{16}$	$\frac{27}{8}$	$\frac{13}{32}$	$\frac{9}{16}$	$\frac{3}{4}$	$\frac{1}{4}$	$\frac{1}{16}$	8	$\frac{25}{32}$	1	$\frac{7}{8}$	$\frac{15}{32}$	$\frac{11}{16}$	$\frac{1}{2}$	$\frac{5}{8}$
5	$\frac{5}{8}$	$\frac{21}{32}$	$\frac{121}{64}$	$\frac{27}{64}$	$\frac{319}{32}$	$\frac{123}{64}$	$\frac{45}{64}$	$\frac{15}{16}$	$\frac{5}{16}$	$\frac{5}{64}$	10	$\frac{31}{32}$	$\frac{1}{2}$	$\frac{13}{32}$	$\frac{123}{64}$	$\frac{227}{64}$	$\frac{17}{8}$	$\frac{25}{32}$
6	$\frac{3}{4}$	$\frac{3}{16}$	$\frac{19}{32}$	$\frac{21}{32}$	$\frac{45}{16}$	$\frac{11}{64}$	$\frac{27}{32}$	$\frac{1}{8}$	$\frac{3}{8}$	$\frac{3}{32}$	12	$\frac{11}{64}$	$\frac{1}{2}$	$\frac{15}{16}$	$\frac{213}{64}$	$\frac{259}{32}$	$\frac{21}{4}$	$\frac{15}{16}$
7	$\frac{7}{8}$	$\frac{323}{64}$	$\frac{155}{64}$	$\frac{261}{64}$	$\frac{53}{32}$	$\frac{129}{32}$	$\frac{53}{64}$	$\frac{13}{16}$	$\frac{7}{16}$	$\frac{7}{64}$	14	$\frac{123}{64}$	$\frac{1}{2}$	$\frac{11}{32}$	$\frac{219}{64}$	$\frac{355}{64}$	$\frac{25}{8}$	$\frac{13}{32}$
8	1	$\frac{4}{4}$	$\frac{2}{8}$	$\frac{3}{8}$	$\frac{5}{4}$	$\frac{2}{8}$	$\frac{11}{8}$	$\frac{1}{2}$	$\frac{1}{2}$	$\frac{1}{8}$	16	$\frac{11}{16}$	2	$\frac{1}{4}$	$\frac{215}{16}$	$\frac{37}{8}$	3	$\frac{1}{4}$
12	$\frac{1}{2}$	$\frac{6}{8}$	$\frac{3}{16}$	$\frac{5}{16}$	$\frac{8}{8}$	$\frac{3}{32}$	$\frac{11}{16}$	$\frac{2}{4}$	$\frac{3}{4}$	$\frac{3}{16}$	24	$\frac{211}{32}$	3	$\frac{2}{8}$	$\frac{413}{32}$	$\frac{513}{16}$	$\frac{4}{2}$	$\frac{1}{8}$
18	$\frac{2}{4}$	$\frac{9}{16}$	$\frac{427}{64}$	$\frac{73}{32}$	$\frac{121}{16}$	$\frac{41}{16}$	$\frac{217}{32}$	$\frac{3}{8}$	$\frac{1}{8}$	$\frac{3}{8}$	36	$\frac{3}{2}$	$\frac{4}{2}$	$\frac{313}{16}$	$\frac{613}{64}$	$\frac{61}{4}$	$\frac{21}{16}$	

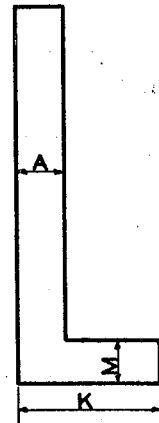
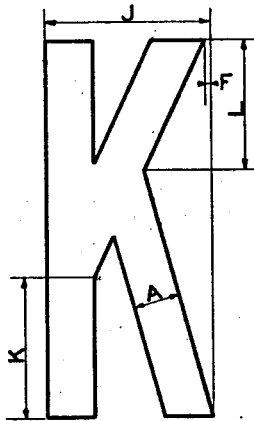
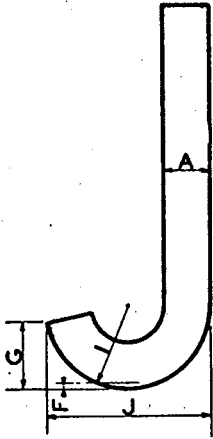
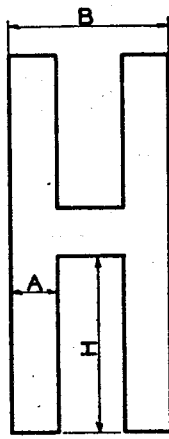
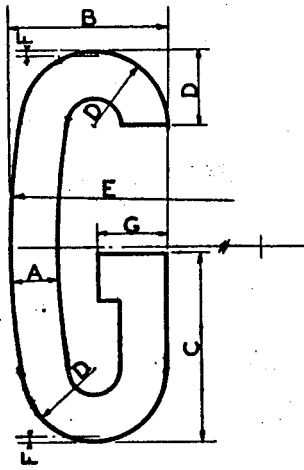

### SERIES B LETTERS

HEIGHT (INCHES)	DIMENSIONS (INCHES)												
	A	B	C	D	E	F	G	H	I	J	K	L	M
2	$\frac{1}{4}$	$\frac{37}{32}$	1	$\frac{25}{32}$	4	$\frac{1}{32}$	$\frac{3}{8}$	$\frac{15}{16}$	$\frac{7}{8}$	$\frac{7}{8}$	$\frac{3}{4}$	$\frac{11}{16}$	$\frac{15}{16}$
3	$\frac{3}{8}$	$1\frac{17}{64}$	$1\frac{1}{2}$	$\frac{27}{32}$	6	$\frac{3}{64}$	$\frac{9}{16}$	$1\frac{13}{32}$	$\frac{21}{32}$	$1\frac{5}{16}$	$1\frac{1}{8}$	$1\frac{13}{32}$	$\frac{31}{32}$
4	$\frac{1}{2}$	$1\frac{11}{16}$	2	$\frac{29}{32}$	8	$\frac{1}{16}$	$\frac{3}{4}$	$1\frac{7}{8}$	$\frac{7}{8}$	$1\frac{3}{4}$	$1\frac{1}{2}$	$1\frac{3}{8}$	$\frac{33}{32}$
5	$\frac{5}{8}$	$2\frac{7}{64}$	$2\frac{1}{2}$	$\frac{31}{32}$	10	$\frac{5}{64}$	$\frac{15}{16}$	$2\frac{11}{32}$	$1\frac{13}{32}$	$2\frac{3}{16}$	$1\frac{7}{8}$	$1\frac{13}{32}$	$\frac{27}{16}$
6	$\frac{3}{4}$	$2\frac{17}{32}$	3	$1\frac{11}{64}$	12	$\frac{3}{32}$	$1\frac{1}{8}$	$2\frac{13}{32}$	$1\frac{15}{16}$	$2\frac{5}{8}$	$2\frac{1}{4}$	$2\frac{1}{16}$	$\frac{29}{16}$
7	$\frac{7}{8}$	$2\frac{21}{64}$	$3\frac{1}{2}$	$1\frac{13}{32}$	14	$\frac{7}{64}$	$1\frac{1}{8}$	$3\frac{11}{32}$	$1\frac{17}{32}$	$3\frac{1}{16}$	$2\frac{5}{8}$	$2\frac{11}{32}$	$\frac{17}{8}$
8	1	$3\frac{3}{8}$	4	$1\frac{15}{16}$	16	$\frac{1}{8}$	$1\frac{1}{2}$	$3\frac{3}{4}$	$1\frac{3}{4}$	$3\frac{1}{2}$	3	$2\frac{3}{4}$	$\frac{19}{8}$
12	$1\frac{1}{2}$	$5\frac{5}{16}$	6	$2\frac{11}{32}$	24	$\frac{3}{16}$	$2\frac{1}{4}$	$5\frac{5}{8}$	$2\frac{5}{8}$	5 $\frac{1}{4}$	$4\frac{1}{2}$	4 $\frac{1}{8}$	$1\frac{13}{8}$
18	$2\frac{1}{4}$	$7\frac{13}{32}$	9	$3\frac{1}{2}$	36	$\frac{5}{32}$	$3\frac{3}{8}$	$8\frac{7}{16}$	$3\frac{11}{16}$	$7\frac{7}{8}$	$6\frac{3}{4}$	$6\frac{5}{16}$	$2\frac{1}{2}$

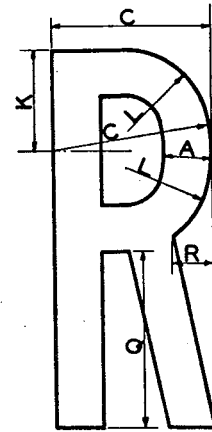
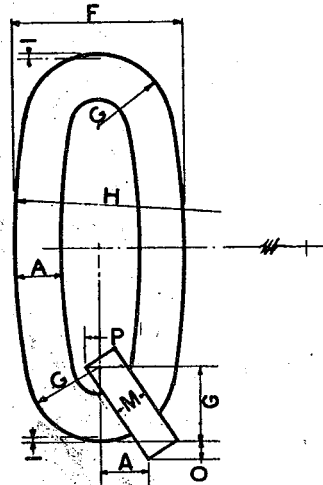
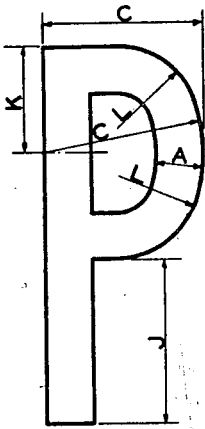
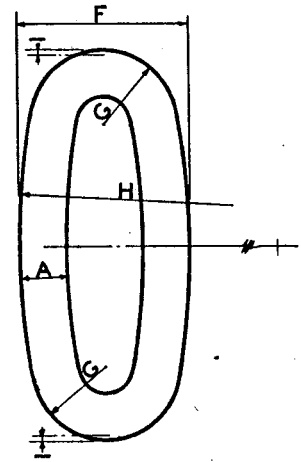
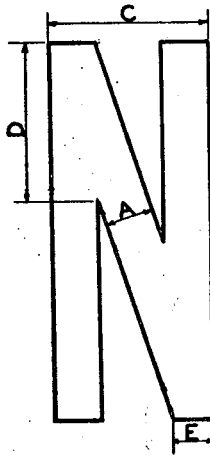
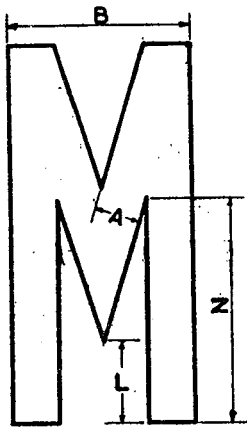

### SERIES B LETTERS

HEIGHT (INCHES)	DIMENSIONS (INCHES)																	
	A	B	C	D	E	F	G	H	I	J	K	L	M	N	O	P	Q	R
2	$\frac{1}{4}$	$\frac{31}{32}$	$\frac{27}{32}$	$\frac{13}{16}$	$\frac{7}{32}$	$\frac{29}{32}$	$\frac{25}{64}$	4	$\frac{1}{32}$	$\frac{7}{8}$	$\frac{17}{32}$	$\frac{7}{16}$	$\frac{3}{16}$	$\frac{1}{16}$	$\frac{3}{32}$	$\frac{5}{64}$	$\frac{15}{64}$	$\frac{13}{64}$
3	$\frac{3}{8}$	$\frac{129}{64}$	$\frac{117}{64}$	$\frac{17}{32}$	$\frac{21}{64}$	$\frac{123}{64}$	$\frac{37}{64}$	6	$\frac{3}{64}$	$\frac{15}{16}$	$\frac{21}{64}$	$\frac{21}{32}$	$\frac{9}{32}$	$\frac{125}{32}$	$\frac{9}{64}$	$\frac{7}{64}$	$\frac{13}{32}$	$\frac{19}{64}$
4	$\frac{1}{2}$	$\frac{115}{16}$	$\frac{111}{16}$	$\frac{11}{8}$	$\frac{7}{16}$	$\frac{113}{16}$	$\frac{53}{32}$	8	$\frac{1}{16}$	$\frac{1}{4}$	$\frac{11}{16}$	$\frac{7}{8}$	$\frac{3}{8}$	$2\frac{3}{8}$	$\frac{3}{16}$	$\frac{33}{32}$	$\frac{17}{8}$	$\frac{13}{32}$
5	$\frac{5}{8}$	$\frac{227}{64}$	$\frac{215}{64}$	$\frac{23}{32}$	$\frac{23}{64}$	$\frac{215}{64}$	$\frac{31}{32}$	10	$\frac{5}{64}$	$\frac{3}{16}$	$\frac{21}{64}$	$\frac{13}{32}$	$\frac{15}{32}$	$2\frac{31}{32}$	$\frac{15}{64}$	$\frac{3}{16}$	$\frac{21}{32}$	$\frac{1}{2}$
6	$\frac{3}{4}$	$\frac{239}{32}$	$\frac{217}{32}$	$\frac{27}{16}$	$\frac{21}{32}$	$\frac{239}{32}$	$\frac{11}{64}$	12	$\frac{3}{32}$	$\frac{2}{8}$	$\frac{13}{32}$	$\frac{15}{16}$	$\frac{9}{16}$	$3\frac{9}{16}$	$\frac{9}{32}$	$\frac{13}{64}$	$\frac{21}{16}$	$\frac{29}{64}$
7	$\frac{7}{8}$	$\frac{325}{64}$	$\frac{281}{64}$	$\frac{227}{64}$	$\frac{43}{64}$	$\frac{311}{64}$	$\frac{123}{64}$	14	$\frac{7}{64}$	$\frac{3}{16}$	$\frac{125}{64}$	$\frac{17}{32}$	$\frac{21}{32}$	$4\frac{5}{32}$	$\frac{21}{64}$	$\frac{17}{64}$	$\frac{39}{32}$	$\frac{43}{64}$
8	1	$\frac{37}{8}$	$\frac{33}{8}$	$\frac{31}{4}$	$\frac{7}{8}$	$\frac{35}{8}$	$\frac{19}{16}$	16	$\frac{1}{8}$	$\frac{3}{4}$	$\frac{21}{8}$	$\frac{13}{4}$	$\frac{3}{4}$	$4\frac{3}{4}$	$\frac{3}{8}$	$\frac{5}{16}$	$\frac{31}{4}$	$\frac{13}{16}$
12	$1\frac{1}{2}$	$\frac{513}{16}$	$\frac{511}{16}$	$\frac{47}{8}$	$\frac{15}{16}$	$\frac{513}{16}$	$\frac{211}{32}$	24	$\frac{3}{16}$	$\frac{5}{4}$	$\frac{33}{16}$	$\frac{25}{8}$	$\frac{11}{8}$	$7\frac{1}{8}$	$\frac{9}{16}$	$\frac{15}{32}$	$\frac{55}{16}$	$\frac{17}{32}$
18	$2\frac{1}{4}$	$\frac{655}{8}$	$\frac{653}{8}$	$\frac{73}{8}$	$\frac{131}{32}$	$\frac{655}{8}$	$\frac{311}{2}$	36	$\frac{9}{32}$	$\frac{7}{8}$	$\frac{43}{8}$	$\frac{31}{8}$	$\frac{11}{4}$	$10\frac{11}{16}$	$\frac{27}{32}$	$\frac{11}{16}$	$\frac{67}{16}$	$\frac{113}{16}$

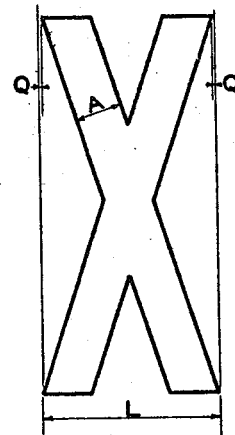
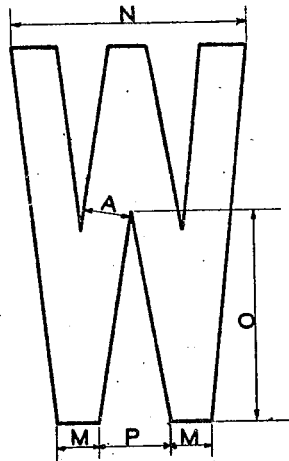
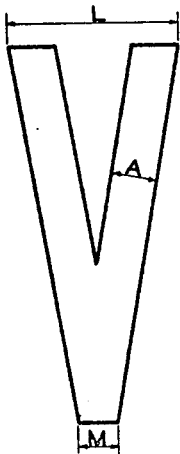
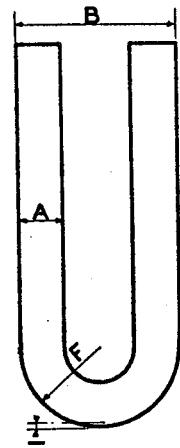
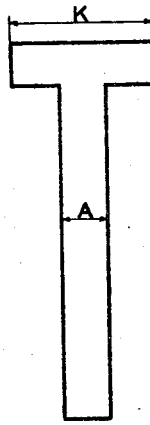
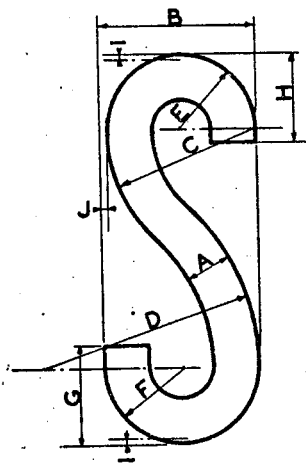

### SERIES B LETTERS

HEIGHT (INCHES)	DIMENSIONS (INCHES)																
	A	B	C	D	E	F	G	H	I	J	K	L	M	N	O	P	Q
2	$\frac{1}{4}$	$\frac{27}{64}$	$\frac{51}{64}$	$\frac{15}{32}$	$\frac{25}{64}$	$\frac{27}{64}$	$\frac{17}{32}$	$\frac{15}{32}$	$\frac{1}{32}$	$\frac{3}{64}$	$\frac{3}{4}$	$\frac{29}{64}$	$\frac{7}{32}$	$\frac{1}{4}$	$\frac{1}{8}$	$\frac{3}{8}$	$\frac{1}{64}$
3	$\frac{3}{8}$	$\frac{17}{64}$	$\frac{13}{16}$	$\frac{17}{64}$	$\frac{19}{32}$	$\frac{5}{8}$	$\frac{51}{64}$	$\frac{45}{64}$	$\frac{3}{64}$	$\frac{1}{16}$	$\frac{1}{8}$	$\frac{13}{8}$	$\frac{21}{64}$	$\frac{17}{8}$	$\frac{11}{16}$	$\frac{9}{16}$	$\frac{1}{64}$
4	$\frac{1}{2}$	$\frac{11}{16}$	$\frac{19}{32}$	$2\frac{1}{8}$	$\frac{51}{64}$	$\frac{27}{32}$	$\frac{11}{16}$	$\frac{15}{16}$	$\frac{1}{16}$	$\frac{3}{32}$	$\frac{1}{2}$	$\frac{127}{16}$	$\frac{7}{16}$	$2\frac{1}{2}$	$2\frac{1}{4}$	$\frac{3}{4}$	$\frac{1}{32}$
5	$\frac{5}{8}$	$2\frac{1}{64}$	$\frac{183}{64}$	$2\frac{27}{64}$	1	$\frac{17}{64}$	$\frac{181}{64}$	$\frac{11}{64}$	$\frac{5}{64}$	$\frac{7}{64}$	$1\frac{7}{8}$	$2\frac{19}{64}$	$\frac{35}{64}$	$3\frac{1}{8}$	$2\frac{13}{16}$	$\frac{15}{16}$	$\frac{1}{32}$
6	$\frac{3}{4}$	$2\frac{17}{32}$	$2\frac{25}{64}$	$3\frac{13}{32}$	$\frac{13}{16}$	$\frac{17}{64}$	$\frac{119}{32}$	$\frac{113}{32}$	$\frac{3}{32}$	$\frac{9}{64}$	$2\frac{1}{4}$	$2\frac{29}{64}$	$\frac{51}{32}$	$3\frac{3}{4}$	$3\frac{3}{8}$	$\frac{1}{8}$	$\frac{1}{64}$
7	$\frac{7}{8}$	$2\frac{81}{64}$	$2\frac{29}{32}$	$4\frac{3}{64}$	$\frac{125}{64}$	$\frac{15}{32}$	$\frac{161}{64}$	$\frac{141}{64}$	$\frac{7}{64}$	$\frac{5}{32}$	$2\frac{5}{8}$	$3\frac{7}{32}$	$\frac{29}{64}$	$4\frac{3}{8}$	$3\frac{15}{16}$	$\frac{15}{16}$	$\frac{1}{64}$
8	1	$3\frac{3}{8}$	$3\frac{1}{8}$	$4\frac{5}{8}$	$\frac{119}{32}$	$\frac{11}{16}$	$2\frac{1}{8}$	$\frac{17}{8}$	$\frac{1}{8}$	$\frac{3}{16}$	3	$3\frac{11}{16}$	$\frac{7}{8}$	5	$4\frac{1}{2}$	$1\frac{1}{2}$	$\frac{1}{16}$
12	$1\frac{1}{2}$	$5\frac{1}{16}$	$4\frac{29}{32}$	$6\frac{13}{32}$	$2\frac{25}{64}$	$2\frac{17}{32}$	$3\frac{1}{16}$	$2\frac{13}{16}$	$\frac{3}{16}$	$\frac{3}{32}$	$4\frac{1}{2}$	$5\frac{17}{32}$	$\frac{11}{16}$	$7\frac{1}{2}$	$6\frac{3}{4}$	$2\frac{1}{4}$	$\frac{1}{32}$
18	$2\frac{1}{4}$	$7\frac{19}{32}$	$7\frac{5}{32}$	$10\frac{13}{32}$	$3\frac{27}{64}$	$3\frac{1}{64}$	$4\frac{29}{32}$	$4\frac{7}{32}$	$\frac{9}{32}$	$\frac{7}{16}$	$6\frac{3}{4}$	$8\frac{11}{16}$	$\frac{11}{16}$	$11\frac{1}{4}$	$10\frac{1}{8}$	$3\frac{3}{8}$	$\frac{1}{8}$

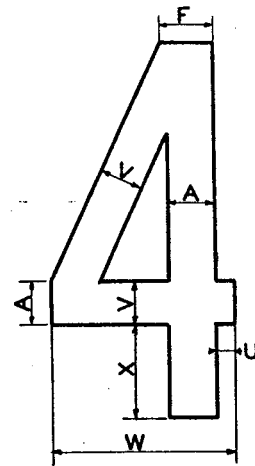
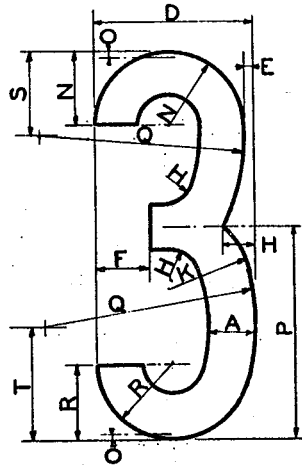
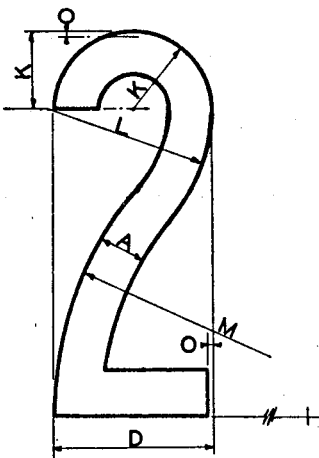
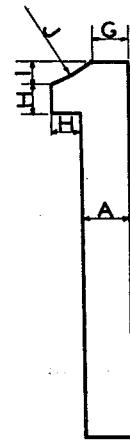
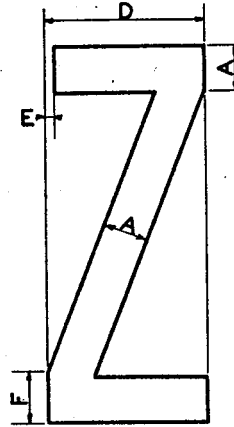
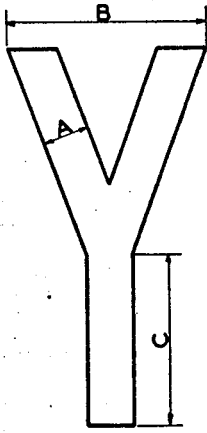

## SERIES B LETTERS AND NUMERALS

HEIGHT (INCHES)	DIMENSIONS (INCHES)																								
	A	B	C	D	E	F	G	H	I	J	K	L	M	N	O	P	Q	R	S	T	U	V	W	X	
2	$\frac{1}{4}$	$\frac{1}{16}$	$\frac{3}{32}$	$\frac{27}{32}$	$\frac{3}{64}$	$\frac{3}{32}$	$\frac{7}{16}$	$\frac{5}{32}$	$\frac{1}{8}$	$\frac{23}{64}$	$\frac{27}{64}$	$\frac{7}{8}$	$\frac{1}{16}$	$\frac{25}{64}$	$\frac{1}{32}$	$\frac{1}{8}$	$\frac{3}{32}$	$\frac{13}{32}$	$\frac{29}{64}$	$\frac{19}{32}$	$\frac{3}{32}$	$\frac{15}{64}$	$\frac{31}{64}$	$\frac{1}{2}$	
3	$\frac{3}{8}$	$\frac{1}{32}$	$\frac{13}{32}$	$\frac{17}{64}$	$\frac{1}{16}$	$\frac{27}{64}$	$\frac{9}{32}$	$\frac{15}{64}$	$\frac{7}{16}$	$\frac{1}{2}$	$\frac{1}{16}$	$\frac{1}{16}$	$\frac{23}{32}$	$\frac{19}{32}$	$\frac{3}{64}$	$\frac{1}{16}$	$\frac{1}{64}$	$\frac{39}{64}$	$\frac{43}{64}$	$\frac{57}{64}$	$\frac{9}{64}$	$\frac{11}{32}$	$\frac{129}{64}$	$\frac{3}{4}$	
4	$\frac{1}{2}$	$2\frac{1}{8}$	$\frac{11}{16}$	$\frac{1}{16}$	$\frac{3}{32}$	$\frac{1}{16}$	$\frac{3}{8}$	$\frac{1}{8}$	$\frac{1}{4}$	$\frac{1}{16}$	$\frac{27}{32}$	$\frac{1}{4}$	$3\frac{3}{8}$	$\frac{21}{64}$	$\frac{1}{16}$	$2\frac{1}{4}$	$2\frac{1}{16}$	$\frac{1}{8}$	$\frac{39}{32}$	$\frac{1}{16}$	$\frac{7}{16}$	$\frac{15}{32}$	$\frac{115}{64}$	1	
5	$\frac{5}{8}$	$2\frac{3}{8}$	$2\frac{17}{64}$	$2\frac{1}{64}$	$\frac{7}{64}$	$\frac{45}{64}$	$\frac{15}{32}$	$\frac{25}{64}$	$\frac{1}{16}$	$\frac{1}{64}$	$\frac{1}{64}$	$2\frac{3}{8}$	$4\frac{17}{32}$	1	$\frac{5}{64}$	$2\frac{1}{16}$	$2\frac{27}{64}$	$\frac{1}{64}$	$\frac{1}{8}$	$\frac{1}{64}$	$\frac{15}{64}$	$\frac{27}{64}$	$2\frac{27}{64}$	$1\frac{1}{4}$	
6	$\frac{3}{4}$	$3\frac{3}{8}$	$2\frac{23}{32}$	$2\frac{17}{32}$	$\frac{9}{64}$	$\frac{27}{32}$	$\frac{1}{16}$	$\frac{15}{32}$	$\frac{3}{8}$	$2\frac{3}{32}$	$\frac{1}{24}$	$2\frac{3}{8}$	$5\frac{7}{16}$	$\frac{1}{16}$	$\frac{3}{32}$	$3\frac{3}{8}$	$3\frac{3}{32}$	$\frac{1}{32}$	$\frac{1}{64}$	$\frac{1}{32}$	$\frac{9}{32}$	$\frac{45}{64}$	$2\frac{29}{32}$	$1\frac{1}{2}$	
7	$\frac{7}{8}$	$3\frac{23}{32}$	$3\frac{11}{64}$	$2\frac{21}{64}$	$\frac{5}{32}$	$\frac{23}{64}$	$\frac{3}{16}$	$\frac{25}{64}$	$\frac{7}{16}$	$2\frac{23}{32}$	$\frac{1}{16}$	$3\frac{1}{16}$	$6\frac{5}{16}$	$\frac{1}{24}$	$\frac{7}{64}$	$3\frac{1}{16}$	$3\frac{23}{64}$	$\frac{1}{64}$	$\frac{1}{24}$	$\frac{1}{64}$	$2\frac{5}{64}$	$\frac{21}{64}$	$\frac{1}{16}$	$3\frac{25}{64}$	$1\frac{3}{4}$
8	1	$4\frac{1}{4}$	$3\frac{3}{8}$	$3\frac{3}{16}$	$\frac{1}{16}$	$\frac{1}{8}$	$\frac{1}{4}$	$\frac{3}{8}$	$\frac{1}{2}$	$2\frac{1}{8}$	$\frac{1}{16}$	$3\frac{1}{2}$	$7\frac{1}{16}$	$\frac{1}{16}$	$\frac{1}{8}$	$4\frac{1}{2}$	$4\frac{3}{8}$	$\frac{1}{8}$	$\frac{1}{16}$	$2\frac{3}{8}$	$\frac{3}{8}$	$\frac{1}{16}$	$3\frac{7}{8}$	2	
12	$1\frac{1}{2}$	$6\frac{3}{8}$	$5\frac{7}{16}$	$5\frac{1}{16}$	$\frac{3}{32}$	$\frac{1}{16}$	$\frac{1}{8}$	$\frac{1}{8}$	$\frac{1}{4}$	$4\frac{1}{16}$	$2\frac{1}{32}$	$5\frac{1}{4}$	$10\frac{7}{8}$	$2\frac{23}{32}$	$\frac{1}{16}$	$6\frac{3}{4}$	$6\frac{1}{8}$	$2\frac{7}{16}$	$2\frac{3}{32}$	$3\frac{1}{16}$	$\frac{1}{8}$	$\frac{1}{32}$	$5\frac{1}{16}$	$5\frac{1}{16}$	3
18	$2\frac{1}{4}$	$9\frac{9}{16}$	$8\frac{5}{32}$	$7\frac{13}{32}$	$\frac{7}{16}$	$2\frac{17}{32}$	$\frac{1}{16}$	$\frac{1}{16}$	$\frac{1}{8}$	$6\frac{5}{32}$	$3\frac{13}{16}$	$7\frac{7}{8}$	$16\frac{1}{8}$	$3\frac{27}{64}$	$\frac{3}{32}$	$10\frac{1}{8}$	$9\frac{27}{32}$	$3\frac{1}{32}$	$4\frac{3}{32}$	$5\frac{1}{32}$	$\frac{27}{32}$	$2\frac{1}{8}$	$8\frac{27}{32}$	$4\frac{1}{2}$	

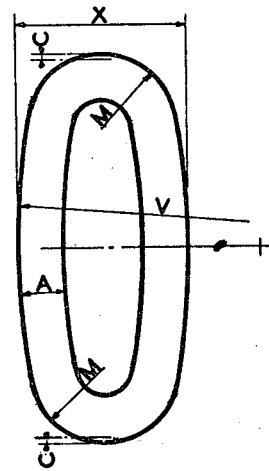
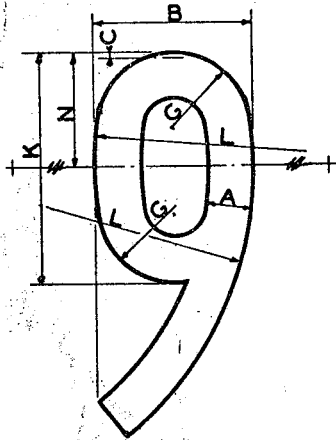
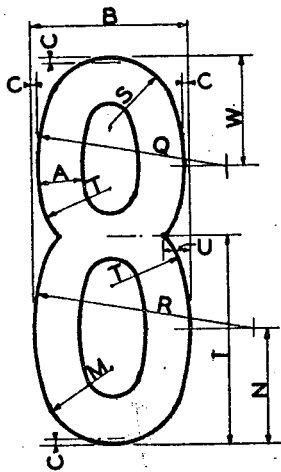
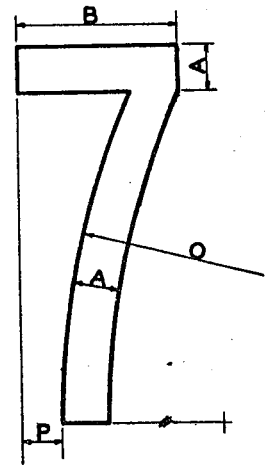
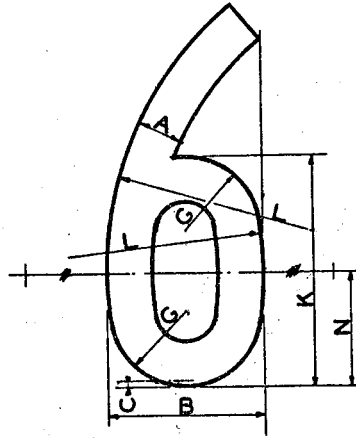
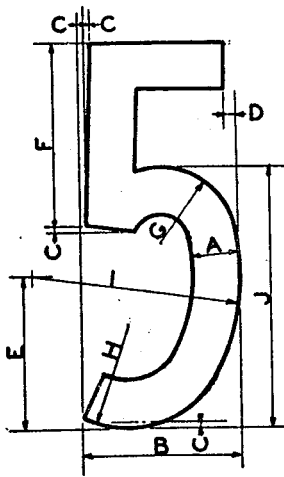

## SERIES B NUMERALS

HEIGHT (INCHES)	DIMENSIONS (INCHES)																							
	A	B	C	D	E	F	G	H	I	J	K	L	M	N	O	P	Q	R	S	T	U	V	W	X
2	$\frac{1}{4}$	$\frac{37}{32}$	$\frac{3}{32}$	$\frac{1}{16}$	$\frac{13}{16}$	$\frac{31}{32}$	$\frac{13}{32}$	$\frac{25}{32}$	$\frac{1}{32}$	$\frac{1}{8}$	$\frac{1}{32}$	$\frac{13}{32}$	$\frac{23}{32}$	$\frac{23}{32}$	$4\frac{3}{8}$	$\frac{3}{32}$	1	$\frac{1}{64}$	$\frac{11}{32}$	$\frac{3}{8}$	$\frac{3}{32}$	4	$\frac{27}{32}$	$\frac{27}{32}$
3	$\frac{3}{8}$	$\frac{17}{64}$	$\frac{3}{64}$	$\frac{3}{32}$	$\frac{17}{32}$	$\frac{129}{64}$	$\frac{29}{32}$	$\frac{13}{16}$	$\frac{1}{32}$	$\frac{2}{16}$	$\frac{1}{32}$	$\frac{23}{32}$	$\frac{23}{32}$	$\frac{23}{32}$	$6\frac{3}{16}$	$\frac{21}{64}$	$\frac{1}{2}$	$\frac{1}{4}$	$\frac{33}{64}$	$\frac{3}{16}$	$\frac{1}{64}$	6	$\frac{27}{32}$	$\frac{127}{64}$
4	$\frac{1}{2}$	$\frac{1}{16}$	$\frac{1}{16}$	$\frac{1}{8}$	$\frac{1}{8}$	$\frac{11}{8}$	$\frac{13}{16}$	$\frac{1}{32}$	$2\frac{3}{16}$	$2\frac{3}{8}$	$2\frac{7}{16}$	$3\frac{1}{16}$	$\frac{23}{32}$	$\frac{13}{32}$	$8\frac{3}{4}$	$\frac{7}{16}$	2	$2\frac{11}{16}$	$\frac{11}{16}$	$\frac{3}{4}$	$\frac{1}{8}$	8	$\frac{1}{32}$	$\frac{1}{16}$
5	$\frac{5}{8}$	$2\frac{3}{64}$	$\frac{3}{64}$	$\frac{3}{32}$	$2\frac{3}{32}$	$\frac{227}{64}$	$\frac{1}{64}$	$\frac{127}{64}$	$2\frac{27}{64}$	$3\frac{7}{16}$	$3\frac{3}{8}$	$4\frac{23}{32}$	$\frac{23}{32}$	$\frac{13}{32}$	$10\frac{1}{8}$	$\frac{33}{64}$	$2\frac{1}{2}$	$2\frac{23}{32}$	$\frac{23}{32}$	$\frac{15}{16}$	$\frac{27}{64}$	10	$\frac{17}{16}$	$2\frac{17}{64}$
6	$\frac{3}{4}$	$2\frac{17}{32}$	$\frac{3}{32}$	$\frac{7}{16}$	$2\frac{7}{16}$	$2\frac{23}{32}$	$\frac{7}{32}$	$\frac{1}{32}$	$3\frac{3}{32}$	$4\frac{1}{8}$	$3\frac{3}{32}$	$5\frac{17}{32}$	$\frac{1}{16}$	$\frac{127}{64}$	$\frac{13}{16}$	$\frac{21}{32}$	3	$3\frac{23}{32}$	$\frac{1}{32}$	$\frac{1}{8}$	$\frac{11}{32}$	12	$\frac{127}{64}$	$2\frac{23}{32}$
7	$\frac{7}{8}$	$2\frac{29}{64}$	$\frac{7}{64}$	$\frac{7}{32}$	$2\frac{27}{32}$	$3\frac{29}{64}$	$\frac{127}{64}$	$\frac{1}{32}$	$3\frac{23}{32}$	$4\frac{1}{16}$	$4\frac{17}{64}$	$6\frac{23}{64}$	$\frac{127}{64}$	$2\frac{1}{8}$	$15\frac{3}{8}$	$\frac{23}{32}$	$3\frac{1}{2}$	$4\frac{3}{32}$	$\frac{13}{64}$	$\frac{1}{16}$	$\frac{27}{64}$	14	$2\frac{29}{64}$	$3\frac{1}{64}$
8	1	$3\frac{3}{8}$	$\frac{1}{8}$	$\frac{1}{4}$	$3\frac{1}{4}$	$3\frac{7}{8}$	$\frac{1}{8}$	$2\frac{7}{8}$	$4\frac{3}{8}$	$5\frac{1}{2}$	$4\frac{7}{8}$	$7\frac{3}{8}$	$\frac{1}{16}$	$2\frac{7}{8}$	$17\frac{1}{2}$	$\frac{7}{8}$	4	$4\frac{1}{16}$	$\frac{1}{8}$	$\frac{1}{2}$	$\frac{3}{8}$	16	$2\frac{7}{16}$	$3\frac{3}{8}$
12	$1\frac{1}{2}$	$5\frac{1}{16}$	$\frac{3}{16}$	$\frac{3}{8}$	$4\frac{7}{8}$	$5\frac{13}{16}$	$2\frac{7}{16}$	$3\frac{3}{32}$	$6\frac{3}{16}$	$8\frac{1}{4}$	$7\frac{5}{16}$	$11\frac{1}{16}$	$2\frac{11}{32}$	$3\frac{21}{32}$	$26\frac{1}{4}$	$\frac{15}{16}$	6	$7\frac{1}{32}$	$2\frac{1}{16}$	$2\frac{1}{8}$	$\frac{15}{16}$	24	$3\frac{13}{32}$	$5\frac{7}{16}$
18	$2\frac{1}{4}$	$7\frac{13}{32}$	$\frac{3}{32}$	$\frac{3}{16}$	$7\frac{5}{16}$	$8\frac{23}{32}$	$3\frac{23}{32}$	$4\frac{1}{16}$	$9\frac{27}{32}$	$12\frac{3}{8}$	$10\frac{3}{16}$	$16\frac{13}{32}$	$3\frac{1}{2}$	$5\frac{1}{2}$	$39\frac{3}{8}$	$\frac{31}{32}$	9	$10\frac{17}{32}$	$3\frac{3}{32}$	$3\frac{3}{8}$	$\frac{13}{32}$	36	$5\frac{3}{16}$	$8\frac{3}{32}$

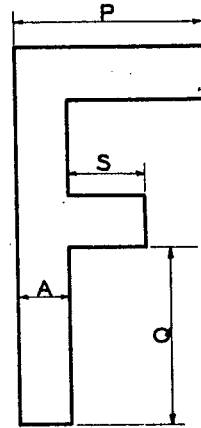
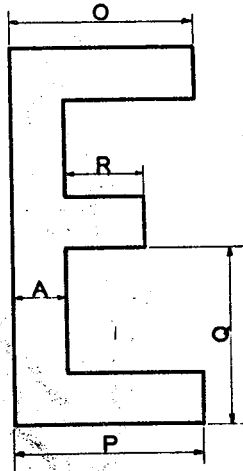
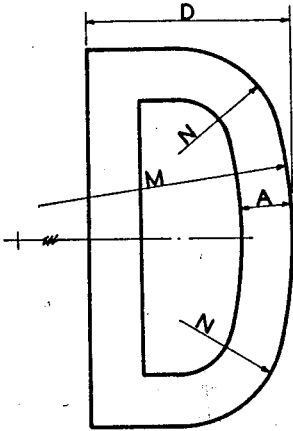
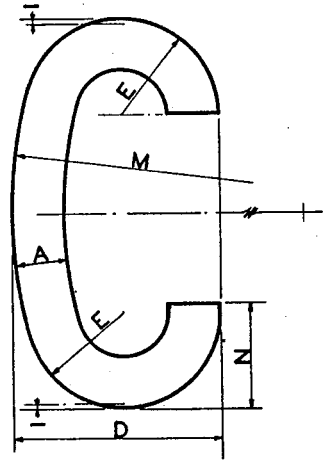
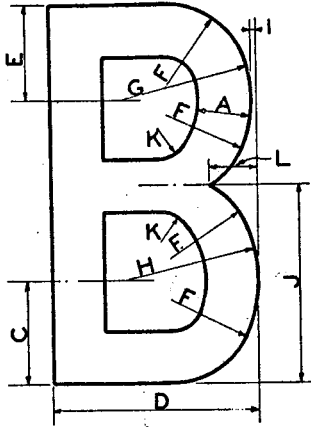
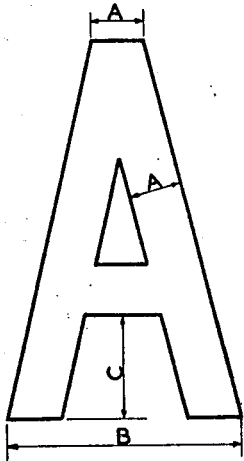

### SERIES C LETTERS

HEIGHT (INCHES)	DIMENSIONS (INCHES)																		
	A	B	C	D	E	F	G	H	I	J	K	L	M	N	O	P	Q	R	S
2	$\frac{9}{32}$	$\frac{1}{4}$	$\frac{33}{64}$	$\frac{13}{32}$	$\frac{1}{2}$	$\frac{7}{16}$	$\frac{11}{16}$	$\frac{23}{32}$	$\frac{1}{32}$	$\frac{13}{64}$	$\frac{5}{32}$	$\frac{1}{4}$	$2\frac{1}{2}$	$\frac{9}{16}$	$\frac{31}{32}$	1	$\frac{15}{16}$	$\frac{27}{64}$	$\frac{13}{32}$
3	$\frac{27}{64}$	$1\frac{1}{8}$	$\frac{13}{16}$	$\frac{41}{64}$	$\frac{3}{4}$	$\frac{21}{32}$	$1\frac{1}{32}$	$\frac{5}{64}$	$\frac{3}{64}$	$\frac{9}{16}$	$\frac{15}{64}$	$\frac{3}{8}$	$3\frac{3}{4}$	$\frac{27}{32}$	$\frac{29}{64}$	$1\frac{1}{2}$	$\frac{13}{32}$	$\frac{5}{8}$	$\frac{39}{64}$
4	$\frac{9}{16}$	$2\frac{1}{2}$	$\frac{13}{32}$	$2\frac{3}{16}$	$1\frac{5}{16}$	$\frac{7}{8}$	$1\frac{3}{8}$	$\frac{17}{16}$	$\frac{1}{16}$	$2\frac{3}{32}$	$\frac{5}{16}$	$\frac{1}{2}$	5	$1\frac{1}{8}$	$1\frac{11}{16}$	2	$1\frac{7}{8}$	$\frac{37}{32}$	$\frac{19}{16}$
5	$\frac{45}{64}$	$3\frac{1}{8}$	$\frac{123}{64}$	$2\frac{47}{64}$	$\frac{17}{64}$	$\frac{13}{32}$	$\frac{183}{64}$	$\frac{191}{64}$	$\frac{5}{64}$	$2\frac{29}{64}$	$\frac{23}{64}$	$\frac{9}{8}$	$6\frac{1}{4}$	$1\frac{13}{32}$	$2\frac{27}{64}$	$2\frac{1}{2}$	$2\frac{11}{32}$	$\frac{13}{16}$	$\frac{15}{64}$
6	$\frac{37}{32}$	$3\frac{3}{4}$	$\frac{41}{64}$	$3\frac{9}{32}$	$\frac{133}{64}$	$\frac{15}{16}$	$2\frac{1}{16}$	$2\frac{31}{32}$	$\frac{3}{32}$	$3\frac{9}{64}$	$\frac{15}{32}$	$\frac{3}{4}$	$7\frac{1}{2}$	$1\frac{11}{16}$	$2\frac{29}{32}$	3	$2\frac{11}{16}$	$\frac{17}{64}$	$\frac{1}{32}$
7	$\frac{63}{64}$	$4\frac{3}{8}$	$\frac{129}{64}$	$3\frac{53}{64}$	$\frac{117}{32}$	$2\frac{13}{32}$	$2\frac{13}{32}$	$2\frac{23}{64}$	$\frac{7}{64}$	$3\frac{31}{64}$	$\frac{35}{64}$	$\frac{7}{8}$	$8\frac{3}{4}$	$1\frac{31}{32}$	$3\frac{25}{64}$	$3\frac{1}{2}$	$3\frac{9}{32}$	$\frac{15}{32}$	$\frac{127}{64}$
8	$1\frac{1}{8}$	5	$2\frac{7}{16}$	$4\frac{3}{8}$	$2\frac{31}{32}$	$1\frac{3}{4}$	$2\frac{1}{2}$	$2\frac{7}{8}$	$\frac{1}{8}$	$4\frac{3}{16}$	$\frac{5}{8}$	1	10	$2\frac{1}{4}$	$3\frac{7}{8}$	4	$3\frac{3}{4}$	$1\frac{11}{16}$	$1\frac{5}{8}$
12	$1\frac{11}{16}$	$7\frac{1}{2}$	$3\frac{31}{32}$	$6\frac{7}{16}$	$3\frac{27}{64}$	$2\frac{3}{8}$	$4\frac{1}{8}$	$4\frac{1}{16}$	$\frac{3}{16}$	$6\frac{3}{32}$	$\frac{15}{16}$	$1\frac{1}{2}$	15	$3\frac{3}{8}$	$5\frac{13}{16}$	6	$5\frac{5}{8}$	$2\frac{11}{32}$	$2\frac{7}{16}$
16	$2\frac{17}{32}$	$11\frac{1}{4}$	$4\frac{15}{16}$	$8\frac{27}{32}$	$4\frac{9}{16}$	$3\frac{1}{16}$	$6\frac{3}{16}$	$6\frac{13}{32}$	$\frac{9}{32}$	$9\frac{7}{16}$	$\frac{13}{32}$	$2\frac{1}{4}$	$22\frac{1}{2}$	$5\frac{1}{16}$	$8\frac{53}{32}$	9	$8\frac{7}{16}$	$3\frac{15}{16}$	$3\frac{31}{32}$



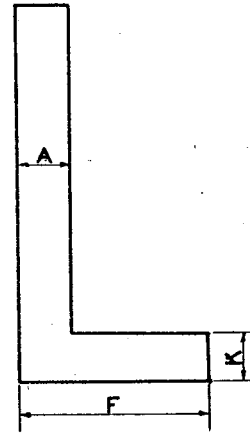
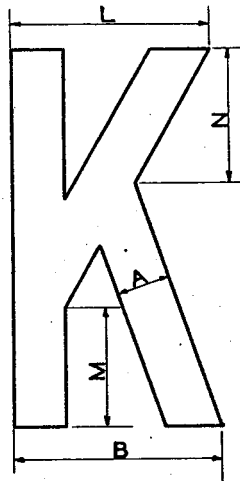
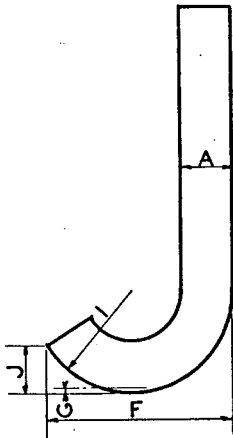
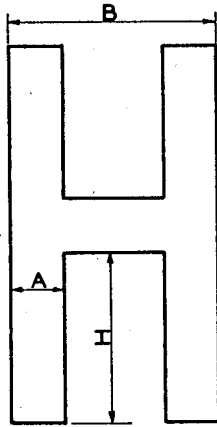
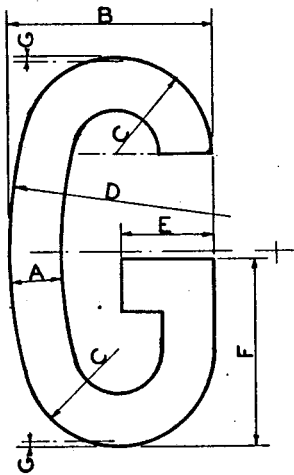

### SERIES C LETTERS

HEIGHT (INCHES)	DIMENSIONS (INCHES)													
	A	B	C	D	E	F	G	H	I	J	K	L	M	N
2	$\frac{3}{32}$	$\frac{3}{32}$	$\frac{1}{2}$	$2\frac{1}{2}$	$\frac{1}{2}$	1	$\frac{1}{32}$	$\frac{29}{52}$	$\frac{17}{32}$	$\frac{1}{4}$	$\frac{17}{64}$	$\frac{13}{64}$	$\frac{41}{64}$	$\frac{41}{64}$
3	$\frac{27}{64}$	$\frac{11}{64}$	$\frac{3}{4}$	$3\frac{3}{4}$	$\frac{3}{4}$	$1\frac{1}{2}$	$\frac{3}{64}$	$\frac{123}{64}$	$\frac{21}{64}$	$\frac{3}{8}$	$\frac{25}{64}$	$\frac{9}{16}$	$\frac{61}{64}$	$\frac{13}{64}$
4	$\frac{9}{16}$	$2\frac{3}{16}$	$\frac{1}{64}$	5	1	2	$\frac{1}{16}$	$1\frac{13}{16}$	$\frac{1}{16}$	$\frac{1}{2}$	$\frac{17}{32}$	$2\frac{3}{32}$	$1\frac{3}{32}$	$\frac{13}{32}$
5	$\frac{45}{64}$	$2\frac{47}{64}$	$\frac{17}{64}$	$6\frac{1}{4}$	$1\frac{1}{4}$	$2\frac{1}{2}$	$\frac{5}{64}$	$2\frac{17}{64}$	$\frac{121}{64}$	$\frac{5}{8}$	$\frac{21}{32}$	$2\frac{39}{64}$	$\frac{19}{32}$	$\frac{13}{4}$
6	$\frac{27}{32}$	$3\frac{9}{32}$	$1\frac{33}{64}$	$7\frac{1}{2}$	$1\frac{1}{2}$	3	$\frac{3}{32}$	$2\frac{23}{32}$	$\frac{119}{32}$	$\frac{3}{4}$	$\frac{51}{64}$	$3\frac{9}{64}$	$\frac{159}{64}$	$2\frac{7}{64}$
7	$\frac{63}{64}$	$3\frac{23}{64}$	$\frac{23}{64}$	$8\frac{3}{4}$	$1\frac{3}{4}$	$3\frac{1}{2}$	$\frac{7}{64}$	$3\frac{11}{64}$	$1\frac{55}{64}$	$\frac{7}{8}$	$\frac{59}{64}$	$3\frac{21}{32}$	$2\frac{15}{64}$	$2\frac{29}{64}$
8	$1\frac{1}{8}$	$4\frac{3}{8}$	$2\frac{1}{32}$	10	2	4	$\frac{1}{8}$	$3\frac{5}{8}$	$2\frac{1}{8}$	1	$1\frac{1}{16}$	$4\frac{3}{16}$	$2\frac{9}{16}$	$2\frac{13}{16}$
12	$1\frac{11}{16}$	$6\frac{9}{16}$	$3\frac{3}{64}$	15	3	6	$\frac{3}{16}$	$5\frac{7}{16}$	$3\frac{3}{16}$	$1\frac{1}{2}$	$1\frac{19}{32}$	$6\frac{9}{32}$	$3\frac{27}{32}$	$4\frac{7}{32}$
18	$2\frac{17}{32}$	$9\frac{27}{32}$	$4\frac{9}{16}$	$22\frac{1}{2}$	$4\frac{1}{2}$	9	$\frac{9}{32}$	$8\frac{5}{32}$	$4\frac{25}{32}$	$2\frac{1}{4}$	$2\frac{3}{8}$	$9\frac{7}{16}$	$5\frac{3}{4}$	$6\frac{9}{16}$

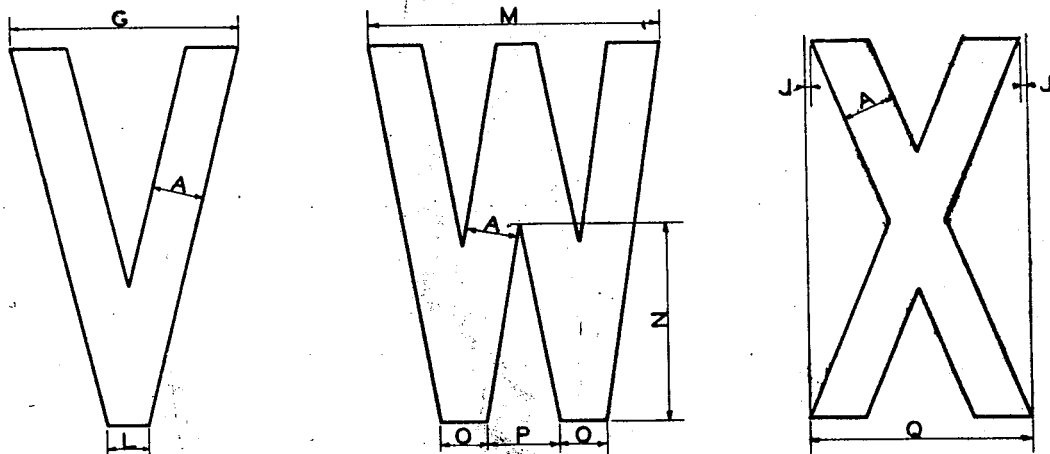
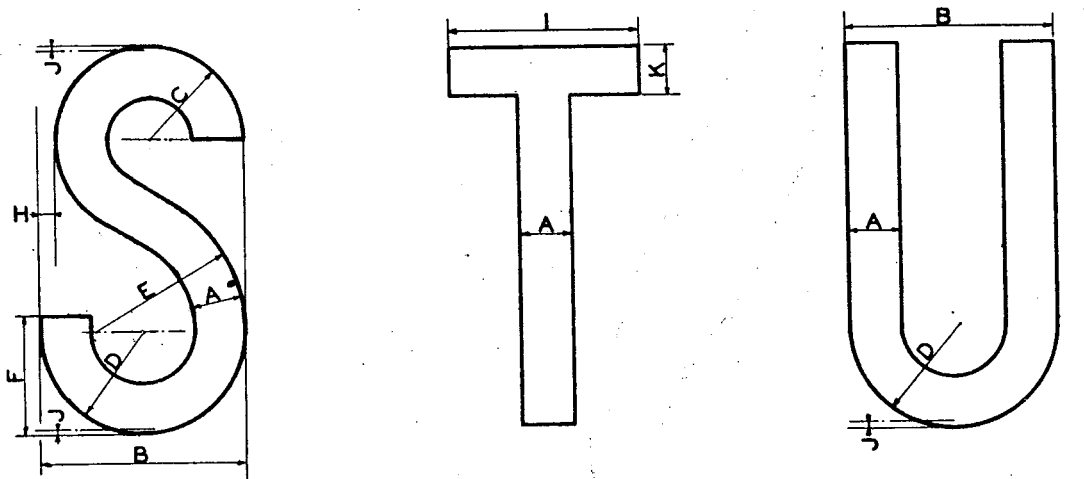

### SERIES C LETTERS

HEIGHT (INCHES)	DIMENSIONS (INCHES)																
	A	B	C	D	E	F	G	H	I	J	K	L	M	N	O	P	Q
2	$\frac{3}{32}$	$\frac{13}{64}$	$\frac{1}{2}$	$\frac{35}{64}$	$\frac{13}{16}$	$\frac{5}{8}$	$\frac{17}{32}$	$\frac{3}{32}$	1	$\frac{1}{32}$	$\frac{17}{64}$	$\frac{7}{32}$	$1\frac{1}{2}$	$\frac{15}{64}$	$\frac{1}{4}$	$\frac{3}{8}$	$1\frac{1}{4}$
3	$\frac{27}{64}$	$\frac{41}{64}$	$\frac{3}{4}$	$\frac{13}{16}$	$\frac{17}{32}$	$\frac{15}{16}$	$\frac{53}{64}$	$\frac{3}{64}$	$1\frac{1}{2}$	$\frac{3}{64}$	$\frac{25}{64}$	$\frac{21}{64}$	$2\frac{1}{4}$	$1\frac{1}{16}$	$\frac{5}{8}$	$\frac{9}{16}$	$1\frac{3}{4}$
4	$\frac{9}{16}$	$2\frac{1}{16}$	1	$\frac{1}{32}$	$\frac{1}{8}$	$1\frac{1}{4}$	$2\frac{7}{16}$	$\frac{3}{16}$	2	$\frac{1}{16}$	$\frac{17}{32}$	$\frac{7}{16}$	3	$2\frac{3}{32}$	$\frac{1}{8}$	$\frac{3}{4}$	$2\frac{1}{32}$
5	$\frac{23}{32}$	$2\frac{27}{64}$	$1\frac{1}{4}$	$\frac{1}{8}$	$2\frac{1}{32}$	$1\frac{1}{8}$	$3\frac{1}{16}$	$\frac{1}{8}$	$2\frac{1}{2}$	$\frac{5}{64}$	$\frac{31}{32}$	$\frac{23}{64}$	$3\frac{3}{4}$	$2\frac{29}{64}$	$\frac{5}{8}$	$\frac{11}{16}$	$2\frac{23}{32}$
6	$\frac{37}{64}$	$3\frac{3}{32}$	$1\frac{1}{2}$	$\frac{11}{64}$	$2\frac{7}{16}$	$1\frac{7}{8}$	$3\frac{3}{32}$	$\frac{3}{32}$	3	$\frac{3}{32}$	$\frac{21}{64}$	$\frac{21}{32}$	$4\frac{1}{2}$	$3\frac{3}{64}$	$\frac{3}{4}$	$1\frac{1}{8}$	$3\frac{23}{64}$
7	$\frac{51}{64}$	$3\frac{33}{64}$	$1\frac{3}{4}$	$\frac{1}{32}$	$2\frac{27}{32}$	$2\frac{3}{16}$	$4\frac{17}{64}$	$\frac{21}{64}$	$3\frac{1}{2}$	$\frac{7}{64}$	$\frac{29}{64}$	$\frac{49}{64}$	$5\frac{1}{4}$	$3\frac{31}{64}$	$\frac{7}{8}$	$1\frac{5}{8}$	$4\frac{3}{32}$
8	$1\frac{1}{8}$	$4\frac{3}{8}$	2	$2\frac{3}{16}$	$\frac{3}{4}$	$2\frac{1}{2}$	$4\frac{7}{8}$	$\frac{3}{8}$	4	$\frac{1}{8}$	$1\frac{1}{16}$	$\frac{7}{8}$	6	$4\frac{1}{16}$	1	$1\frac{1}{2}$	$4\frac{11}{16}$
12	$1\frac{11}{16}$	$6\frac{9}{16}$	3	$3\frac{3}{32}$	$4\frac{7}{8}$	$3\frac{3}{4}$	$7\frac{7}{8}$	$\frac{9}{16}$	6	$\frac{3}{16}$	$1\frac{13}{32}$	$\frac{5}{16}$	9	$6\frac{3}{32}$	$1\frac{1}{2}$	$2\frac{1}{4}$	$7\frac{3}{32}$
18	$2\frac{17}{32}$	$9\frac{27}{32}$	$4\frac{1}{2}$	$4\frac{15}{16}$	$7\frac{7}{8}$	$5\frac{5}{8}$	$10\frac{31}{32}$	$\frac{27}{32}$	9	$\frac{9}{32}$	$2\frac{3}{8}$	$1\frac{1}{32}$	$12\frac{1}{2}$	$9\frac{7}{16}$	$2\frac{1}{4}$	$3\frac{3}{8}$	$10\frac{11}{16}$

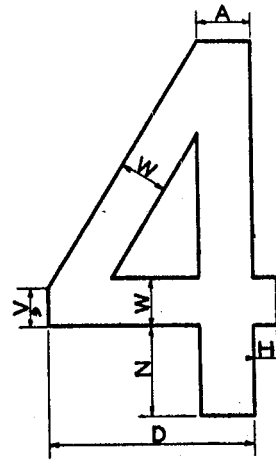
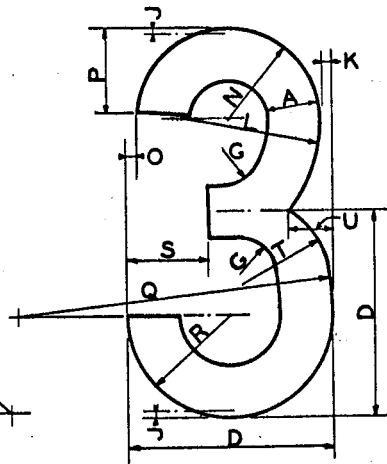
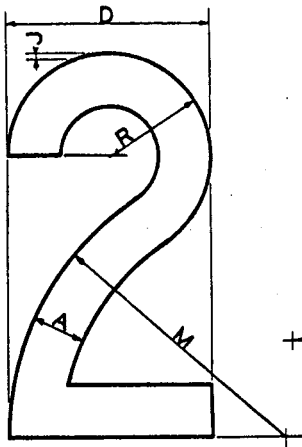
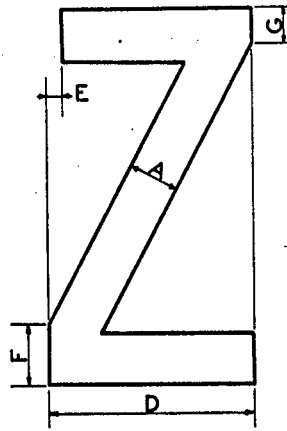
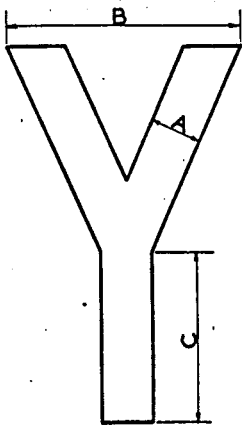

### SERIES C LETTERS AND NUMERALS

HEIGHT (INCHES)	DIMENSIONS (INCHES)																									
	A	B	C	D	E	F	G	H	I	J	K	L	M	N	O	P	Q	R	S	T	U	V	W			
2	3/32	1/4	3/32	1/32	5/64	1/16	3/16	1/8	3/32	3/32	5/64	1/4	1/2	3/4	1/8	3/16	1/32	3/16	1/8	3/16	1/8	3/16	1/8	1/4		
3	3/16	1/2	1/16	1/16	3/16	3/16	3/16	3/16	3/16	3/16	3/16	3/16	3/16	3/16	3/16	3/16	3/16	3/16	3/16	3/16	3/16	3/16	3/16	3/16		
4	1/8	2/4	1/16	2/16	3/8	3/8	3/8	1/4	1/8	1/8	3/8	1/2	3/4	3/8	1/2	3/8	3/8	1/2	3/8	1/8	3/8	1/8	3/8			
5	3/16	3/8	2/16	2/16	3/8	3/8	3/8	3/8	3/8	3/8	3/8	3/8	3/8	3/8	3/8	3/8	3/8	3/8	3/8	3/8	3/8	3/8	3/8			
6	3/8	3/4	2/32	3/32	3/8	3/8	3/8	3/8	3/8	3/8	3/8	3/8	3/8	3/8	3/8	3/8	3/8	3/8	3/8	3/8	3/8	3/8	3/8			
7	3/8	4/8	3/16	3/16	3/8	3/8	3/8	3/8	3/8	3/8	3/8	3/8	3/8	3/8	3/8	3/8	3/8	3/8	3/8	3/8	3/8	3/8	3/8			
8	1/2	5	3/8	4/8	3/8	3/8	3/8	3/8	3/8	3/8	3/8	3/8	3/8	3/8	3/8	3/8	3/8	3/8	3/8	3/8	3/8	3/8	3/8			
12	1/16	7/4	5/16	6/16	3/8	3/8	3/8	3/8	3/8	3/8	3/8	3/8	3/8	3/8	3/8	3/8	3/8	3/8	3/8	3/8	3/8	3/8	3/8			
18	2/32	11/4	8/32	9/8	1/2	1/2	1/2	1/2	1/2	1/2	1/2	1/2	1/2	1/2	1/2	1/2	1/2	1/2	1/2	1/2	1/2	1/2	1/2			

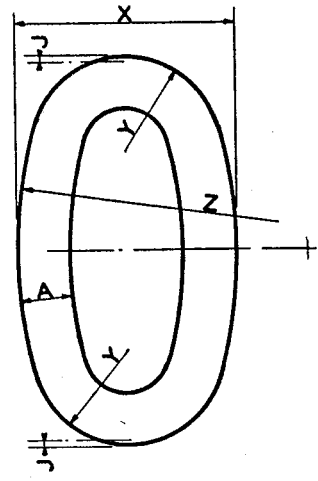
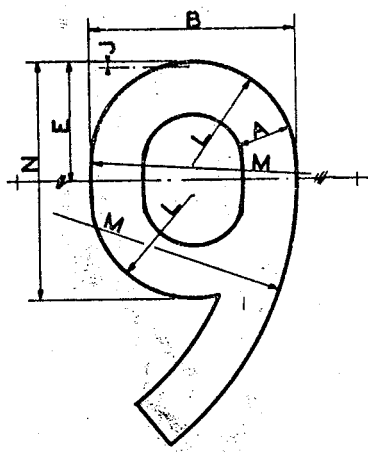
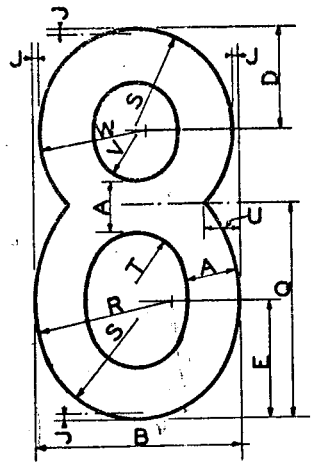
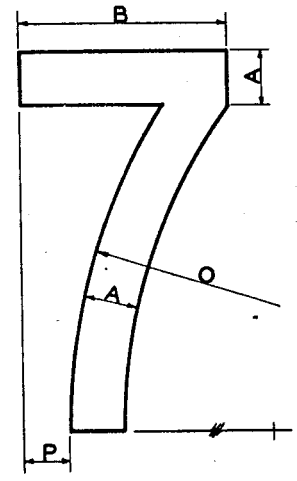
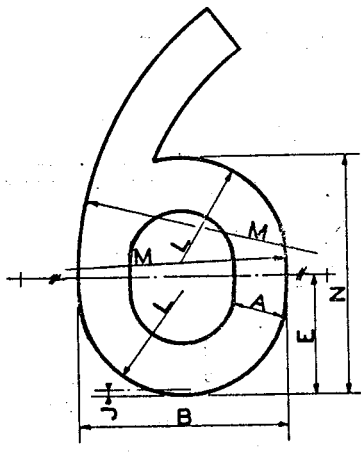
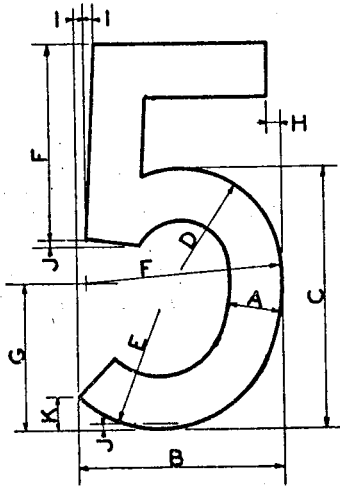

### SERIES C NUMERALS

HEIGHT (INCHES)	DIMENSIONS (INCHES)																									
	A	B	C	D	E	F	G	H	I	J	K	L	M	N	O	P	Q	R	S	T	U	V	W	X	Y	Z
2	$\frac{3}{32}$	$\frac{13}{64}$	$\frac{17}{8}$	$\frac{17}{32}$	$\frac{3}{8}$	$\frac{13}{32}$	$\frac{33}{64}$	$\frac{5}{64}$	$\frac{5}{64}$	$\frac{1}{32}$	$\frac{11}{64}$	$\frac{35}{64}$	$\frac{13}{4}$	$\frac{1}{4}$	$\frac{33}{16}$	$\frac{1}{4}$	$\frac{11}{8}$	$\frac{3}{4}$	$\frac{33}{64}$	$\frac{15}{64}$	$\frac{3}{16}$	$\frac{7}{32}$	$\frac{21}{64}$	$\frac{15}{32}$	$\frac{1}{2}$	$\frac{1}{2}$
3	$\frac{27}{64}$	$\frac{141}{64}$	$\frac{21}{16}$	$\frac{51}{64}$	$\frac{15}{16}$	$\frac{133}{64}$	$\frac{11}{64}$	$\frac{7}{64}$	$\frac{1}{16}$	$\frac{5}{64}$	$\frac{1}{4}$	$\frac{11}{16}$	$\frac{25}{8}$	$\frac{1}{8}$	$\frac{425}{32}$	$\frac{3}{8}$	$\frac{11}{16}$	$\frac{1}{8}$	$\frac{29}{64}$	$\frac{11}{32}$	$\frac{3}{8}$	$\frac{7}{16}$	$\frac{21}{64}$	$\frac{61}{64}$	$\frac{147}{64}$	$\frac{3}{4}$
4	$\frac{9}{16}$	$\frac{23}{16}$	$\frac{23}{4}$	$\frac{11}{16}$	$\frac{1}{4}$	$\frac{21}{16}$	$\frac{19}{16}$	$\frac{5}{32}$	$\frac{3}{32}$	$\frac{1}{16}$	$\frac{11}{32}$	$\frac{13}{32}$	$\frac{31}{2}$	$\frac{21}{2}$	$\frac{63}{8}$	$\frac{1}{2}$	$\frac{21}{4}$	$\frac{123}{64}$	$\frac{13}{32}$	$\frac{15}{32}$	$\frac{3}{8}$	$\frac{7}{16}$	$\frac{35}{64}$	$\frac{19}{32}$	$\frac{57}{64}$	5
5	$\frac{45}{64}$	$\frac{247}{64}$	$\frac{37}{16}$	$\frac{21}{64}$	$\frac{1}{8}$	$\frac{237}{64}$	$\frac{181}{64}$	$\frac{3}{16}$	$\frac{7}{64}$	$\frac{5}{64}$	$\frac{27}{64}$	$\frac{123}{64}$	$\frac{43}{8}$	$\frac{3}{8}$	$\frac{731}{32}$	$\frac{3}{8}$	$\frac{21}{16}$	$\frac{27}{64}$	$\frac{13}{32}$	$\frac{37}{64}$	$\frac{15}{32}$	$\frac{35}{64}$	$\frac{19}{32}$	$\frac{57}{64}$	$\frac{147}{64}$	$\frac{17}{64}$
6	$\frac{27}{32}$	$\frac{33}{32}$	$\frac{41}{8}$	$\frac{19}{32}$	$\frac{7}{8}$	$\frac{33}{32}$	$\frac{211}{32}$	$\frac{15}{64}$	$\frac{9}{64}$	$\frac{3}{32}$	$\frac{33}{64}$	$\frac{41}{64}$	$\frac{51}{4}$	$\frac{3}{4}$	$\frac{919}{16}$	$\frac{3}{4}$	$\frac{43}{8}$	$\frac{9}{2}$	$\frac{123}{64}$	$\frac{45}{64}$	$\frac{9}{16}$	$\frac{61}{32}$	$\frac{29}{64}$	$\frac{35}{32}$	$\frac{123}{64}$	$\frac{1}{2}$
7	$\frac{53}{64}$	$\frac{353}{64}$	$\frac{413}{16}$	$\frac{153}{64}$	$\frac{23}{16}$	$\frac{323}{64}$	$\frac{247}{64}$	$\frac{17}{64}$	$\frac{5}{64}$	$\frac{7}{64}$	$\frac{19}{32}$	$\frac{129}{64}$	$\frac{61}{8}$	$\frac{43}{8}$	$\frac{1153}{32}$	$\frac{7}{8}$	$\frac{31}{16}$	$\frac{231}{32}$	$\frac{151}{64}$	$\frac{13}{16}$	$\frac{21}{32}$	$\frac{49}{64}$	$\frac{25}{64}$	$\frac{43}{64}$	$\frac{117}{64}$	$\frac{61}{64}$
8	$\frac{1}{8}$	$\frac{43}{8}$	$\frac{51}{2}$	$\frac{23}{8}$	$\frac{21}{2}$	$\frac{43}{8}$	$\frac{31}{8}$	$\frac{1}{8}$	$\frac{3}{8}$	$\frac{1}{16}$	$\frac{21}{8}$	7	5	$\frac{123}{4}$	1	$\frac{41}{2}$	$\frac{33}{2}$	$\frac{21}{8}$	$\frac{15}{16}$	$\frac{3}{4}$	$\frac{7}{8}$	$\frac{9}{16}$	$\frac{21}{8}$	$\frac{43}{8}$	$\frac{21}{2}$	10
12	$\frac{11}{16}$	$\frac{61}{16}$	$\frac{61}{4}$	$\frac{31}{16}$	$\frac{33}{4}$	$\frac{61}{16}$	$\frac{41}{16}$	$\frac{15}{32}$	$\frac{9}{32}$	$\frac{3}{16}$	$\frac{13}{32}$	$\frac{39}{32}$	$\frac{101}{2}$	$\frac{71}{2}$	$\frac{191}{8}$	$\frac{1}{2}$	$\frac{63}{4}$	$\frac{35}{4}$	$\frac{39}{2}$	$\frac{13}{2}$	$\frac{11}{8}$	$\frac{11}{16}$	$\frac{27}{32}$	$\frac{61}{16}$	$\frac{361}{64}$	15
18	$\frac{217}{32}$	$\frac{927}{64}$	$\frac{123}{8}$	$\frac{433}{32}$	$\frac{53}{8}$	$\frac{93}{32}$	$\frac{73}{16}$	$\frac{11}{16}$	$\frac{7}{16}$	$\frac{9}{32}$	$\frac{5}{16}$	$\frac{15}{4}$	$\frac{153}{4}$	$\frac{113}{4}$	$\frac{201}{16}$	$\frac{21}{4}$	$\frac{103}{8}$	$\frac{61}{16}$	$\frac{41}{4}$	$\frac{27}{8}$	$\frac{11}{16}$	$\frac{31}{32}$	$\frac{49}{64}$	$\frac{103}{32}$	$\frac{9}{4}$	$\frac{1}{22}$

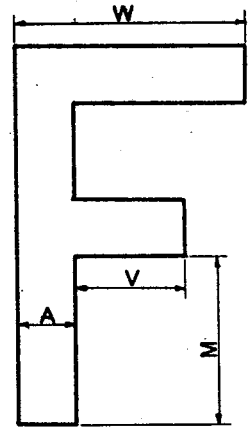
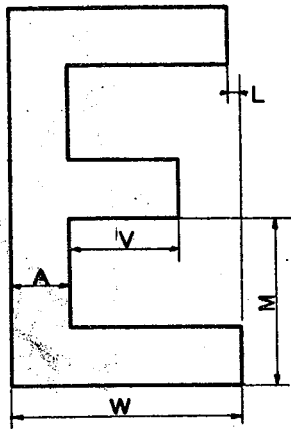
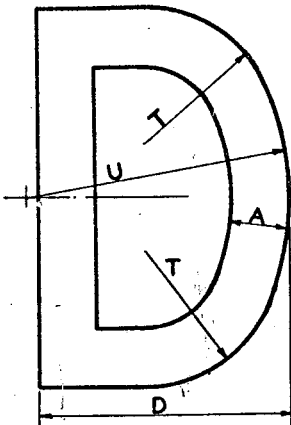
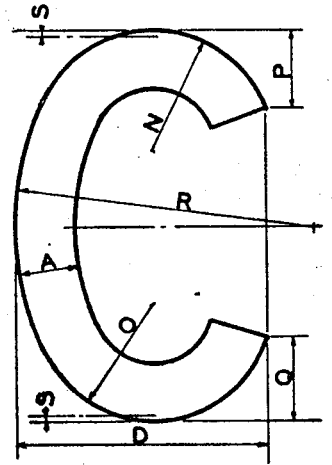
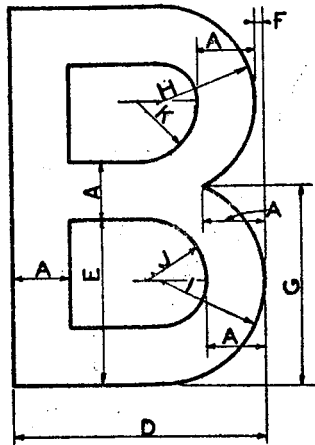
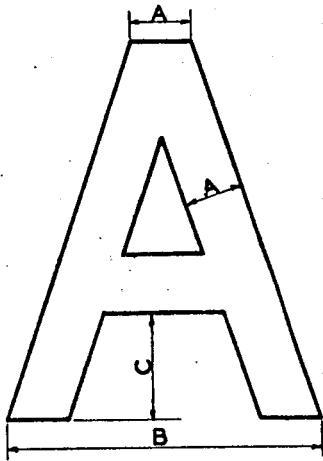

### SERIES D LETTERS

HEIGHT (INCHES)	DIMENSIONS (INCHES)																									
	A	B	C	D	E	F	G	H	I	J	K	L	M	N	O	P	Q	R	S	T	U	V	W			
2	$\frac{1}{8}$	$\frac{13}{32}$	$\frac{3}{16}$	$\frac{1}{32}$	$\frac{7}{8}$	$\frac{3}{4}$	$\frac{1}{64}$	$\frac{1}{2}$	$\frac{33}{64}$	$\frac{21}{64}$	$\frac{5}{16}$	$\frac{1}{16}$	$\frac{7}{8}$	$\frac{21}{32}$	$\frac{41}{64}$	$\frac{13}{32}$	$\frac{7}{16}$	$\frac{1}{16}$	$\frac{3}{2}$	$\frac{23}{32}$	$\frac{13}{32}$	$\frac{37}{64}$	$\frac{17}{32}$			
3	$\frac{15}{32}$	$2\frac{1}{2}$	$\frac{27}{32}$	$2\frac{1}{64}$	$\frac{15}{16}$	$\frac{1}{16}$	$\frac{1}{16}$	$\frac{3}{4}$	$\frac{13}{16}$	$\frac{21}{64}$	$\frac{13}{32}$	$\frac{3}{32}$	$\frac{15}{16}$	$\frac{23}{64}$	$\frac{21}{64}$	$\frac{21}{32}$	$2\frac{3}{8}$	$\frac{3}{64}$	$\frac{1}{64}$	$2\frac{7}{64}$	$\frac{55}{64}$	$\frac{55}{64}$	$\frac{153}{64}$			
4	$\frac{5}{8}$	$3\frac{11}{32}$	$\frac{1}{8}$	$2\frac{1}{16}$	$\frac{1}{4}$	$\frac{3}{32}$	$2\frac{3}{32}$	1	$\frac{13}{32}$	$\frac{21}{32}$	$\frac{5}{8}$	$\frac{1}{8}$	$\frac{3}{4}$	$\frac{1}{16}$	$\frac{13}{32}$	$\frac{13}{16}$	$\frac{7}{8}$	$3\frac{5}{32}$	$\frac{1}{16}$	$\frac{7}{16}$	$2\frac{1}{16}$	$\frac{13}{32}$	$2\frac{7}{16}$			
5	$\frac{5}{32}$	$4\frac{3}{16}$	$\frac{13}{32}$	$3\frac{23}{64}$	$2\frac{3}{16}$	$\frac{7}{64}$	$2\frac{23}{64}$	$\frac{1}{4}$	$\frac{123}{64}$	$\frac{13}{16}$	$\frac{23}{32}$	$\frac{5}{32}$	$2\frac{3}{16}$	$\frac{11}{64}$	$\frac{13}{32}$	$\frac{1}{64}$	$\frac{13}{32}$	$3\frac{13}{16}$	$\frac{5}{64}$	$\frac{51}{64}$	$3\frac{1}{2}$	$\frac{17}{16}$	$3\frac{3}{64}$			
6	$\frac{1}{2}$	$5\frac{3}{64}$	$\frac{1}{16}$	$4\frac{3}{32}$	$2\frac{5}{8}$	$\frac{3}{64}$	$3\frac{3}{64}$	$\frac{1}{2}$	$\frac{121}{64}$	$\frac{23}{64}$	$\frac{15}{16}$	$\frac{3}{16}$	$2\frac{5}{8}$	$\frac{31}{32}$	$\frac{59}{64}$	$\frac{7}{32}$	$4\frac{3}{8}$	$\frac{3}{32}$	$2\frac{33}{64}$	$4\frac{3}{32}$	$\frac{27}{64}$	$\frac{27}{64}$	$4\frac{17}{64}$			
7	$\frac{13}{32}$	$5\frac{27}{32}$	$\frac{3}{32}$	$4\frac{13}{64}$	$3\frac{1}{16}$	$\frac{5}{32}$	$3\frac{21}{64}$	$\frac{1}{4}$	$\frac{137}{32}$	$\frac{1}{64}$	$\frac{13}{32}$	$\frac{7}{32}$	$3\frac{1}{16}$	$2\frac{19}{64}$	$2\frac{15}{64}$	$\frac{127}{64}$	$\frac{17}{32}$	$5\frac{17}{32}$	$\frac{7}{64}$	$2\frac{23}{64}$	$4\frac{59}{64}$	$2\frac{1}{64}$	$4\frac{17}{64}$			
8	$\frac{1}{4}$	$6\frac{11}{16}$	$2\frac{1}{4}$	$5\frac{3}{8}$	$3\frac{1}{2}$	$\frac{3}{16}$	$4\frac{3}{16}$	2	$2\frac{23}{16}$	$\frac{1}{16}$	$\frac{1}{4}$	$3\frac{1}{2}$	$2\frac{5}{8}$	$2\frac{7}{8}$	$\frac{1}{8}$	$\frac{1}{4}$	$6\frac{1}{16}$	$\frac{1}{8}$	$2\frac{7}{8}$	$5\frac{5}{8}$	$2\frac{7}{8}$	$4\frac{7}{8}$				
12	$\frac{17}{8}$	$10\frac{3}{32}$	$3\frac{3}{8}$	$6\frac{1}{16}$	$5\frac{1}{4}$	$\frac{9}{32}$	$6\frac{29}{32}$	3	$3\frac{29}{32}$	$\frac{11}{32}$	$\frac{17}{8}$	$\frac{3}{8}$	$5\frac{1}{4}$	$3\frac{15}{16}$	$3\frac{27}{32}$	$2\frac{7}{16}$	$2\frac{5}{8}$	$9\frac{15}{32}$	$\frac{3}{16}$	$4\frac{5}{16}$	$6\frac{7}{16}$	$3\frac{15}{32}$	$7\frac{1}{16}$			
18	$2\frac{13}{16}$	$15\frac{1}{16}$	$5\frac{1}{16}$	$12\frac{3}{32}$	$7\frac{7}{8}$	$\frac{7}{16}$	$9\frac{7}{16}$	$4\frac{1}{2}$	$4\frac{13}{16}$	$2\frac{13}{16}$	$2\frac{13}{16}$	$\frac{9}{16}$	$7\frac{7}{8}$	$5\frac{29}{32}$	$5\frac{7}{8}$	$3\frac{21}{32}$	$3\frac{15}{16}$	$14\frac{3}{8}$	$\frac{9}{32}$	$6\frac{15}{32}$	$12\frac{31}{32}$	$5\frac{27}{16}$	$10\frac{31}{32}$			

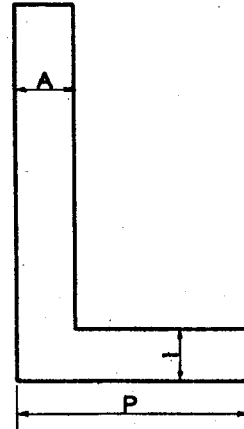
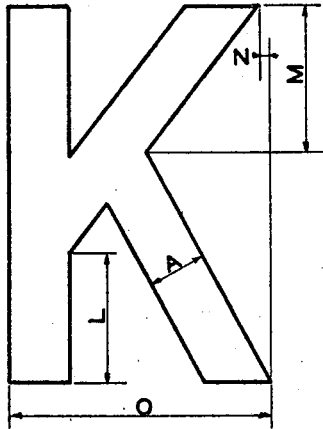
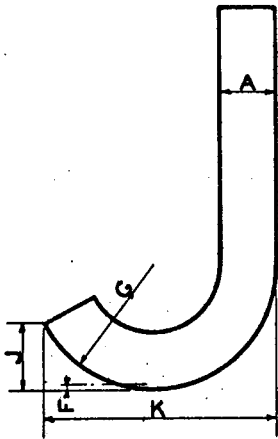
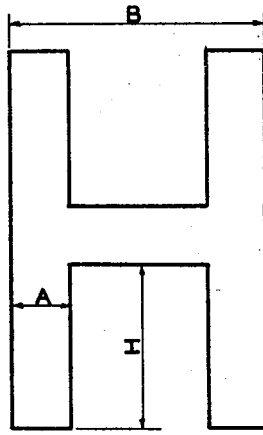
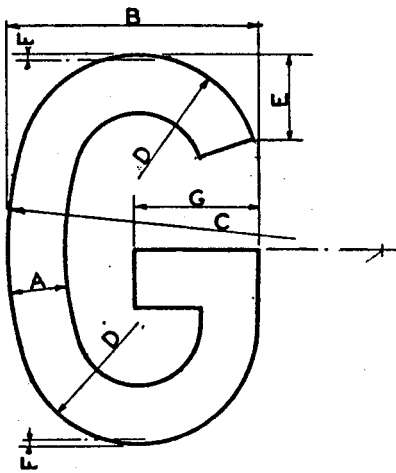

### SERIES D LETTERS

HEIGHT (INCHES)	DIMENSIONS (INCHES)															
	A	B	C	D	E	F	G	H	I	J	K	L	M	N	O	P
2	$\frac{5}{16}$	$1\frac{1}{32}$	2	$\frac{21}{64}$	$\frac{7}{16}$	$\frac{1}{32}$	$\frac{21}{32}$	$\frac{7}{8}$	$\frac{19}{64}$	$\frac{23}{64}$	$1\frac{1}{4}$	$\frac{1}{16}$	$\frac{55}{32}$	$\frac{3}{8}$	$1\frac{3}{8}$	$1\frac{1}{32}$
3	$\frac{15}{32}$	$2\frac{5}{64}$	3	$\frac{81}{64}$	$\frac{31}{32}$	$\frac{3}{64}$	$\frac{83}{64}$	$1\frac{1}{16}$	$\frac{7}{16}$	$\frac{17}{32}$	$1\frac{1}{8}$	$1\frac{1}{32}$	$1\frac{1}{64}$	$\frac{1}{16}$	$2\frac{1}{16}$	$1\frac{23}{64}$
4	$\frac{1}{8}$	$2\frac{1}{16}$	4	$1\frac{11}{32}$	$\frac{7}{8}$	$\frac{1}{16}$	$1\frac{1}{16}$	$1\frac{1}{4}$	$\frac{13}{32}$	$\frac{33}{32}$	$2\frac{1}{2}$	$1\frac{1}{8}$	$1\frac{1}{16}$	$\frac{3}{32}$	$2\frac{1}{4}$	$2\frac{1}{16}$
5	$\frac{25}{32}$	$3\frac{23}{64}$	5	$1\frac{19}{32}$	$1\frac{1}{32}$	$\frac{5}{64}$	$1\frac{11}{64}$	$2\frac{1}{16}$	$\frac{47}{64}$	$\frac{57}{64}$	$3\frac{1}{8}$	$1\frac{13}{32}$	$1\frac{1}{64}$	$\frac{7}{64}$	$3\frac{7}{16}$	$3\frac{3}{64}$
6	$\frac{15}{16}$	$4\frac{1}{32}$	6	$1\frac{59}{64}$	$1\frac{1}{16}$	$\frac{3}{32}$	$1\frac{31}{32}$	$2\frac{1}{8}$	$\frac{57}{64}$	$1\frac{5}{64}$	$3\frac{1}{4}$	$2\frac{1}{16}$	$2\frac{11}{32}$	$\frac{3}{8}$	$4\frac{1}{8}$	$3\frac{11}{32}$
7	$1\frac{1}{32}$	$4\frac{25}{64}$	7	$2\frac{15}{64}$	$1\frac{17}{32}$	$\frac{7}{64}$	$2\frac{13}{64}$	$3\frac{1}{16}$	$1\frac{1}{32}$	$1\frac{1}{4}$	$4\frac{1}{8}$	$2\frac{13}{32}$	$2\frac{23}{64}$	$\frac{5}{32}$	$4\frac{1}{16}$	$4\frac{17}{64}$
8	$1\frac{1}{4}$	$5\frac{3}{8}$	8	$2\frac{3}{16}$	$1\frac{1}{4}$	$\frac{1}{8}$	$2\frac{5}{8}$	$3\frac{1}{2}$	$1\frac{3}{16}$	$1\frac{7}{16}$	5	$2\frac{1}{4}$	$3\frac{1}{8}$	$\frac{3}{16}$	$5\frac{1}{2}$	$4\frac{1}{8}$
12	$1\frac{7}{8}$	$8\frac{1}{16}$	12	$3\frac{27}{32}$	$2\frac{5}{8}$	$\frac{3}{16}$	$3\frac{15}{16}$	$5\frac{1}{4}$	$1\frac{25}{32}$	$2\frac{5}{32}$	$7\frac{1}{2}$	$4\frac{1}{8}$	$4\frac{11}{16}$	$\frac{9}{32}$	$8\frac{1}{4}$	$7\frac{1}{16}$
18	$2\frac{13}{16}$	$12\frac{3}{32}$	18	$5\frac{3}{4}$	$3\frac{15}{16}$	$\frac{3}{32}$	$5\frac{23}{32}$	$7\frac{7}{8}$	$2\frac{11}{16}$	$3\frac{1}{4}$	$11\frac{1}{4}$	$6\frac{3}{16}$	$7\frac{1}{32}$	$\frac{7}{16}$	$12\frac{3}{8}$	$10\frac{31}{32}$

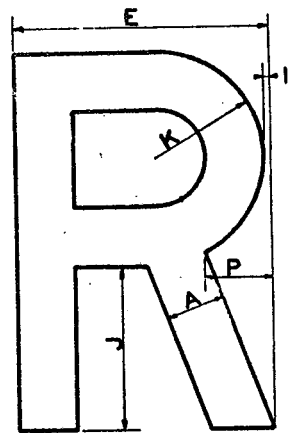
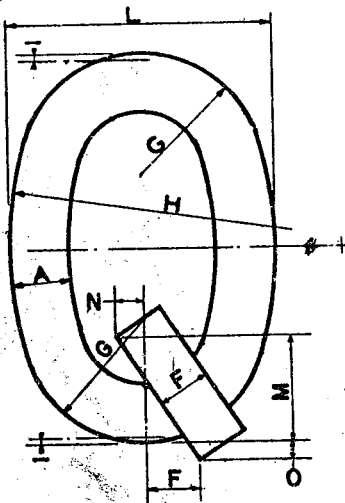
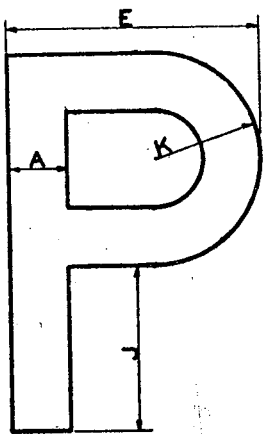
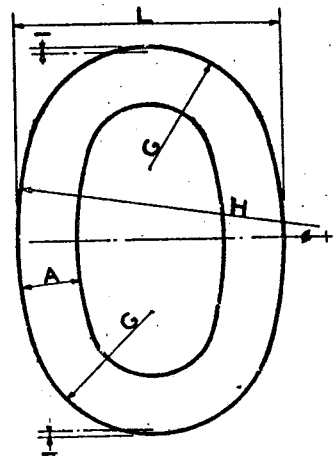
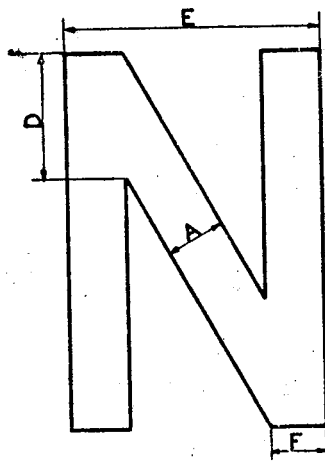
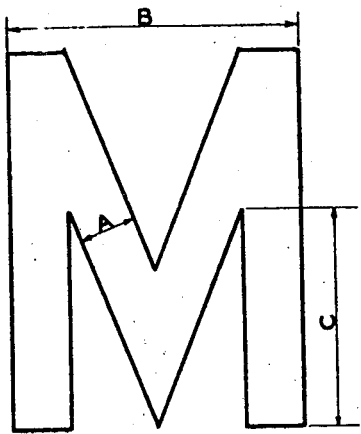

### SERIES D LETTERS

HEIGHT (INCHES)	DIMENSIONS (INCHES)															
	A	B	C	D	E	F	G	H	I	J	K	L	M	N	O	P
2	$\frac{5}{16}$	$1\frac{13}{32}$	$\frac{15}{32}$	$\frac{23}{64}$	$1\frac{11}{32}$	$\frac{33}{32}$	$\frac{21}{64}$	2	$\frac{1}{32}$	$\frac{7}{8}$	$\frac{2}{16}$	$1\frac{13}{32}$	$\frac{16}{16}$	$\frac{3}{32}$	$\frac{3}{32}$	$\frac{11}{32}$
3	$\frac{13}{32}$	$2\frac{7}{16}$	$1\frac{27}{64}$	1	$2\frac{1}{64}$	$\frac{27}{64}$	$\frac{21}{64}$	3	$\frac{3}{64}$	$1\frac{5}{16}$	$\frac{27}{32}$	$2\frac{7}{64}$	$\frac{27}{32}$	$\frac{15}{64}$	$\frac{2}{64}$	$\frac{23}{64}$
4	$\frac{3}{8}$	$3\frac{3}{32}$	$2\frac{7}{16}$	$1\frac{11}{32}$	$2\frac{11}{16}$	$\frac{2}{16}$	$1\frac{3}{32}$	4	$\frac{1}{16}$	$1\frac{1}{4}$	$1\frac{1}{8}$	$2\frac{13}{16}$	$1\frac{1}{8}$	$\frac{2}{16}$	$\frac{3}{16}$	$\frac{1}{16}$
5	$\frac{23}{32}$	$3\frac{23}{64}$	$2\frac{27}{64}$	$1\frac{23}{64}$	$3\frac{23}{64}$	$\frac{23}{32}$	$1\frac{13}{32}$	5	$\frac{5}{64}$	$2\frac{7}{16}$	$1\frac{13}{32}$	$3\frac{1}{2}$	$1\frac{13}{32}$	$\frac{25}{64}$	$\frac{15}{64}$	$\frac{23}{64}$
6	$\frac{15}{16}$	$4\frac{21}{64}$	$3\frac{13}{32}$	$2\frac{21}{64}$	$4\frac{13}{32}$	$\frac{27}{32}$	$1\frac{23}{64}$	6	$\frac{3}{32}$	$2\frac{3}{8}$	$1\frac{11}{16}$	$4\frac{5}{32}$	$1\frac{11}{16}$	$\frac{15}{32}$	$\frac{2}{32}$	$1\frac{1}{32}$
7	$1\frac{3}{32}$	$5\frac{13}{32}$	$4\frac{21}{64}$	$2\frac{11}{32}$	$4\frac{13}{64}$	$\frac{23}{64}$	$2\frac{15}{64}$	7	$\frac{7}{64}$	$3\frac{1}{16}$	$1\frac{31}{32}$	$4\frac{23}{64}$	$1\frac{31}{32}$	$\frac{23}{64}$	$\frac{21}{64}$	$1\frac{13}{64}$
8	$1\frac{1}{4}$	$6\frac{7}{16}$	$4\frac{3}{8}$	$2\frac{11}{16}$	$5\frac{3}{8}$	$1\frac{1}{8}$	$2\frac{7}{16}$	8	$\frac{1}{8}$	$3\frac{1}{2}$	$2\frac{1}{4}$	$5\frac{5}{8}$	$2\frac{1}{4}$	$\frac{5}{8}$	$\frac{3}{8}$	$1\frac{3}{8}$
12	$1\frac{7}{8}$	$9\frac{23}{32}$	$6\frac{13}{16}$	$4\frac{31}{32}$	$8\frac{1}{16}$	$1\frac{1}{16}$	$3\frac{27}{32}$	12	$\frac{3}{16}$	$5\frac{1}{4}$	$3\frac{3}{8}$	$8\frac{7}{16}$	$3\frac{3}{8}$	$\frac{15}{16}$	$\frac{2}{16}$	$2\frac{1}{16}$
18	$2\frac{13}{16}$	$13\frac{13}{16}$	$10\frac{13}{32}$	$6\frac{1}{16}$	$12\frac{3}{32}$	$2\frac{17}{32}$	$5\frac{1}{4}$	18	$\frac{2}{32}$	$7\frac{7}{8}$	$5\frac{1}{16}$	$12\frac{21}{32}$	$5\frac{1}{16}$	$1\frac{13}{32}$	$\frac{27}{32}$	$3\frac{3}{32}$

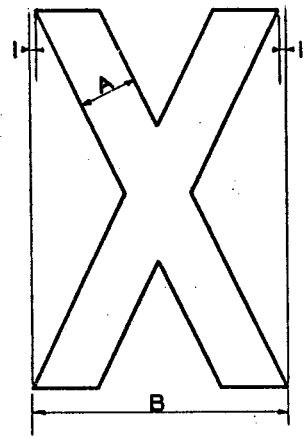
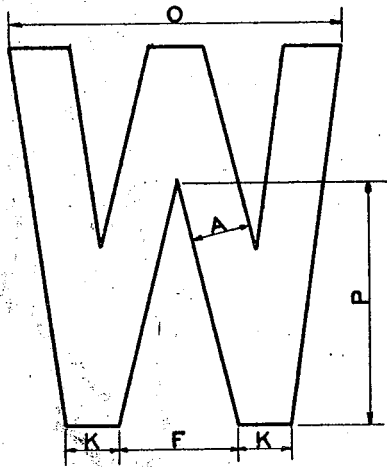
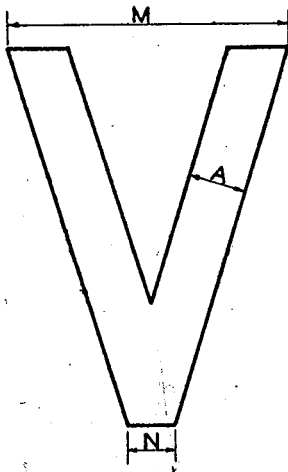
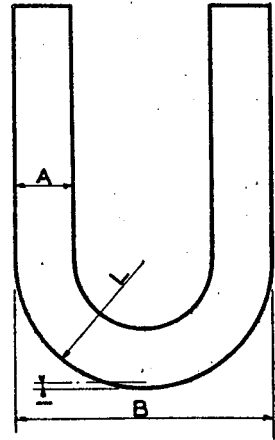
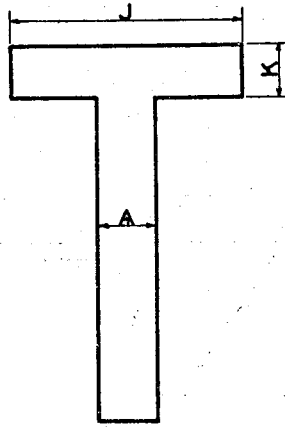
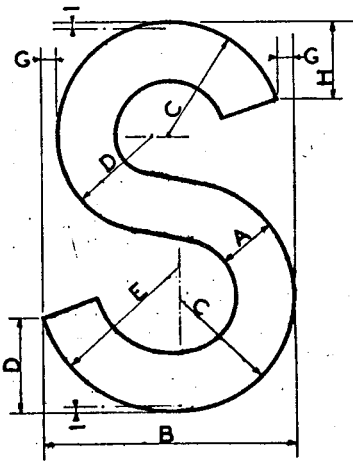

### SERIES D LETTERS

HEIGHT (INCHES)	DIMENSIONS (INCHES)															
	A	B	C	D	E	F	G	H	I	J	K	L	M	N	O	P
2	$\frac{5}{16}$	$\frac{11}{32}$	$\frac{39}{64}$	$\frac{1}{2}$	$\frac{25}{32}$	$\frac{5}{8}$	$\frac{5}{64}$	$\frac{13}{32}$	$\frac{1}{32}$	$\frac{17}{32}$	$\frac{3}{32}$	$\frac{33}{64}$	$\frac{1}{2}$	$\frac{1}{4}$	$\frac{17}{32}$	$\frac{1}{32}$
3	$\frac{15}{32}$	$\frac{2}{64}$	$\frac{39}{32}$	$\frac{3}{4}$	$\frac{11}{64}$	$\frac{15}{16}$	$\frac{7}{64}$	$\frac{39}{64}$	$\frac{3}{64}$	$\frac{13}{32}$	$\frac{27}{64}$	1	$2\frac{1}{4}$	$\frac{3}{8}$	$2\frac{1}{8}$	$\frac{15}{64}$
4	$\frac{5}{8}$	$2\frac{11}{16}$	$\frac{17}{32}$	1	$1\frac{9}{16}$	$1\frac{1}{4}$	$\frac{5}{32}$	$\frac{13}{16}$	$\frac{1}{16}$	$2\frac{7}{16}$	$\frac{9}{16}$	$1\frac{11}{32}$	3	$\frac{1}{2}$	$3\frac{1}{2}$	$2\frac{5}{8}$
5	$\frac{25}{32}$	$3\frac{23}{64}$	$\frac{13}{64}$	$\frac{1}{4}$	$\frac{11}{64}$	$1\frac{9}{16}$	$\frac{3}{16}$	$1\frac{1}{4}$	$\frac{5}{64}$	$3\frac{3}{64}$	$\frac{15}{64}$	$1\frac{13}{64}$	$3\frac{3}{4}$	$\frac{5}{8}$	$4\frac{3}{8}$	$3\frac{15}{64}$
6	$\frac{15}{16}$	$4\frac{1}{32}$	$\frac{13}{64}$	$\frac{1}{2}$	$2\frac{11}{32}$	$1\frac{7}{8}$	$\frac{15}{64}$	$1\frac{7}{32}$	$\frac{3}{32}$	$3\frac{21}{32}$	$\frac{27}{32}$	$2\frac{1}{64}$	$4\frac{1}{2}$	$\frac{3}{4}$	$5\frac{1}{4}$	$3\frac{5}{32}$
7	$1\frac{3}{32}$	$4\frac{21}{64}$	$2\frac{1}{8}$	$1\frac{3}{4}$	$2\frac{47}{64}$	$2\frac{3}{16}$	$\frac{17}{64}$	$\frac{17}{64}$	$\frac{7}{64}$	$4\frac{17}{64}$	$\frac{63}{64}$	$2\frac{11}{32}$	$5\frac{1}{4}$	$\frac{7}{8}$	$6\frac{1}{8}$	$4\frac{21}{64}$
8	$1\frac{1}{4}$	$5\frac{3}{8}$	$2\frac{7}{16}$	2	$3\frac{1}{8}$	$2\frac{1}{2}$	$\frac{5}{16}$	$1\frac{5}{8}$	$\frac{1}{8}$	$4\frac{7}{8}$	$1\frac{1}{8}$	$2\frac{1}{16}$	6	1	7	$5\frac{1}{8}$
12	$1\frac{7}{8}$	$8\frac{1}{16}$	$3\frac{21}{32}$	3	$4\frac{11}{16}$	$3\frac{3}{4}$	$\frac{13}{32}$	$2\frac{7}{16}$	$\frac{3}{16}$	$7\frac{5}{16}$	$1\frac{1}{16}$	$4\frac{1}{32}$	9	$1\frac{1}{2}$	$10\frac{1}{2}$	$7\frac{11}{16}$
18	$2\frac{13}{16}$	$12\frac{31}{32}$	$5\frac{1}{2}$	$4\frac{1}{2}$	$7\frac{1}{32}$	$5\frac{5}{8}$	$\frac{11}{16}$	$3\frac{21}{32}$	$\frac{9}{32}$	$10\frac{21}{32}$	$2\frac{17}{32}$	$6\frac{3}{64}$	$13\frac{1}{2}$	$2\frac{1}{4}$	$15\frac{3}{4}$	$11\frac{17}{32}$



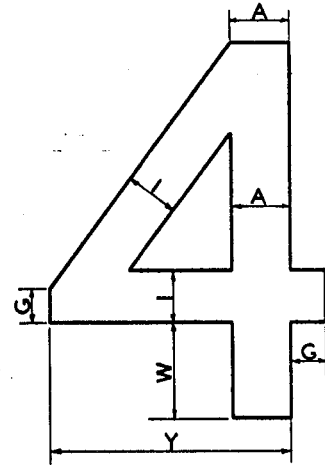
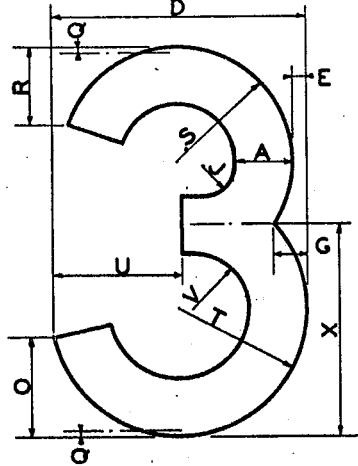
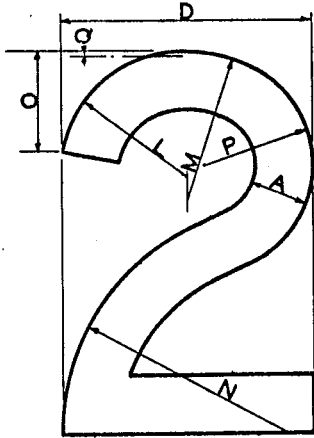
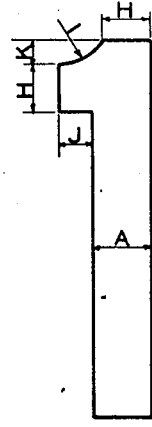
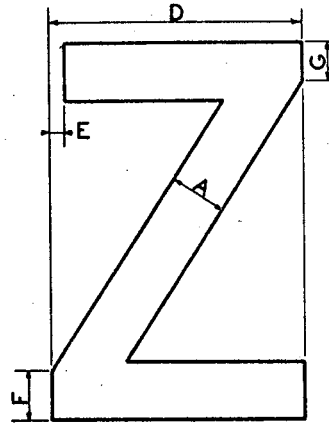
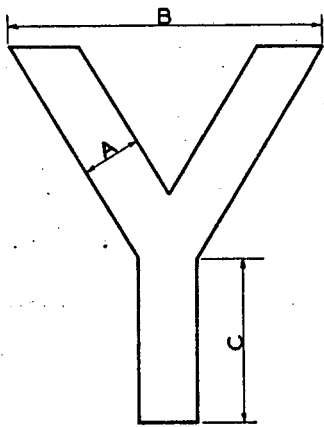

### SERIES D LETTERS AND NUMERALS

HEIGHT (INCHES)	DIMENSIONS (INCHES)																									
	A	B	C	D	E	F	G	H	I	J	K	L	M	N	O	P	Q	R	S	T	U	V	W	X	Y	
2	$\frac{5}{16}$	$\frac{11}{16}$	$\frac{7}{8}$	$\frac{11}{32}$	$\frac{5}{64}$	$\frac{17}{64}$	$\frac{3}{16}$	$\frac{1}{4}$	$\frac{3}{32}$	$\frac{5}{64}$	$\frac{1}{8}$	$\frac{3}{32}$	$\frac{35}{64}$	$\frac{17}{32}$	$\frac{17}{32}$	$\frac{37}{64}$	$\frac{3}{8}$	$\frac{35}{32}$	$\frac{37}{64}$	$\frac{37}{64}$	$\frac{11}{16}$	$\frac{13}{64}$	$\frac{1}{2}$	$\frac{1}{8}$	$\frac{19}{32}$	
3	$\frac{5}{32}$	$\frac{21}{32}$	$\frac{1}{8}$	$\frac{21}{64}$	$\frac{7}{64}$	$\frac{23}{64}$	$\frac{3}{32}$	$\frac{3}{8}$	$\frac{27}{64}$	$\frac{1}{4}$	$\frac{3}{16}$	$\frac{33}{64}$	$\frac{11}{64}$	$\frac{13}{32}$	$\frac{21}{64}$	$\frac{23}{64}$	$\frac{3}{64}$	$\frac{23}{32}$	$\frac{33}{64}$	1	$\frac{1}{32}$	$\frac{7}{16}$	$\frac{3}{4}$	$\frac{11}{16}$	$\frac{13}{32}$	
4	$\frac{3}{8}$	$\frac{3}{8}$	$\frac{1}{4}$	$\frac{21}{16}$	$\frac{5}{32}$	$\frac{17}{32}$	■	$\frac{1}{2}$	$\frac{3}{8}$	$\frac{11}{32}$	$\frac{1}{4}$	$\frac{1}{16}$	$\frac{1}{16}$	$\frac{27}{16}$	$\frac{1}{16}$	$\frac{13}{32}$	$\frac{1}{16}$	$\frac{13}{16}$	$\frac{17}{32}$	$\frac{13}{32}$	$\frac{1}{8}$	$\frac{13}{32}$	1	$\frac{1}{4}$	$\frac{27}{16}$	
5	$\frac{35}{64}$	$\frac{47}{64}$	$\frac{2}{16}$	$\frac{35}{64}$	$\frac{3}{16}$	$\frac{31}{32}$	$\frac{15}{32}$	$\frac{5}{8}$	$\frac{45}{64}$	$\frac{27}{64}$	$\frac{5}{16}$	$\frac{13}{64}$	$\frac{13}{64}$	$\frac{35}{64}$	$\frac{13}{64}$	$\frac{17}{16}$	$\frac{5}{64}$	$\frac{13}{64}$	$\frac{13}{32}$	$\frac{13}{32}$	$\frac{13}{32}$	$\frac{47}{64}$	$\frac{1}{4}$	$\frac{21}{16}$	$\frac{35}{64}$	
6	$\frac{15}{16}$	$\frac{5}{16}$	$\frac{2}{8}$	$\frac{41}{32}$	$\frac{15}{64}$	$\frac{51}{64}$	$\frac{2}{16}$	$\frac{3}{4}$	$\frac{27}{64}$	$\frac{33}{64}$	$\frac{3}{8}$	$\frac{13}{32}$	$\frac{21}{32}$	$\frac{35}{32}$	$\frac{13}{32}$	$\frac{127}{64}$	$\frac{3}{32}$	$\frac{17}{32}$	$\frac{13}{32}$	$\frac{25}{64}$	$\frac{21}{16}$	$\frac{57}{64}$	$\frac{1}{2}$	$\frac{3}{8}$	$\frac{35}{32}$	
7	$\frac{13}{32}$	$\frac{55}{32}$	$\frac{3}{16}$	$\frac{45}{64}$	$\frac{17}{64}$	$\frac{29}{64}$	$\frac{31}{32}$	$\frac{7}{8}$	$\frac{23}{64}$	$\frac{13}{32}$	$\frac{7}{16}$	$\frac{213}{64}$	$\frac{227}{64}$	$\frac{417}{64}$	$\frac{123}{64}$	$\frac{21}{64}$	$\frac{7}{64}$	$\frac{127}{64}$	$\frac{21}{8}$	$\frac{211}{32}$	$\frac{213}{32}$	$\frac{11}{32}$	$\frac{17}{4}$	$\frac{315}{16}$	$\frac{431}{64}$	
8	$\frac{1}{4}$	$\frac{63}{4}$	$\frac{3}{2}$	$\frac{53}{8}$	$\frac{5}{16}$	$\frac{11}{16}$	$\frac{3}{4}$	1	$\frac{1}{8}$	$\frac{11}{16}$	$\frac{1}{2}$	$\frac{25}{8}$	$\frac{3}{8}$	$\frac{47}{8}$	$\frac{21}{8}$	$\frac{215}{16}$	$\frac{1}{8}$	$\frac{15}{8}$	$\frac{27}{16}$	$\frac{211}{16}$	$\frac{23}{4}$	$\frac{13}{16}$	2	$\frac{41}{2}$	$\frac{51}{8}$	
12	$\frac{1}{8}$	$\frac{101}{8}$	$\frac{5}{4}$	$\frac{81}{16}$	$\frac{15}{32}$	$\frac{133}{32}$	$\frac{1}{8}$	$\frac{1}{2}$	$\frac{11}{16}$	$\frac{13}{32}$	$\frac{3}{4}$	$\frac{315}{16}$	$\frac{41}{16}$	$\frac{71}{16}$	$\frac{37}{16}$	$\frac{315}{16}$	$\frac{27}{16}$	$\frac{321}{32}$	$\frac{43}{32}$	$\frac{41}{8}$	$\frac{135}{32}$	3	■	$\frac{3}{4}$	$\frac{71}{16}$	
18	$\frac{213}{16}$	$\frac{153}{16}$	$\frac{7}{8}$	$\frac{123}{32}$	$\frac{11}{16}$	$\frac{23}{8}$	$\frac{11}{16}$	$\frac{21}{4}$	$\frac{217}{32}$	$\frac{1}{16}$	$\frac{1}{8}$	$\frac{523}{32}$	$\frac{71}{32}$	$\frac{1031}{32}$	$\frac{435}{16}$	$\frac{53}{16}$	$\frac{9}{32}$	$\frac{321}{32}$	$\frac{51}{2}$	$\frac{61}{16}$	$\frac{63}{16}$	$\frac{211}{16}$	$\frac{41}{2}$	$\frac{101}{8}$	$\frac{1117}{32}$	

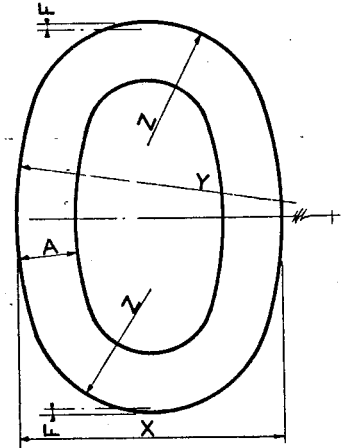
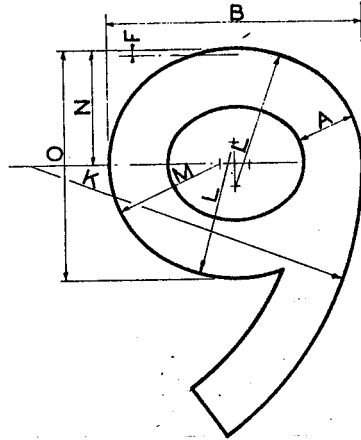
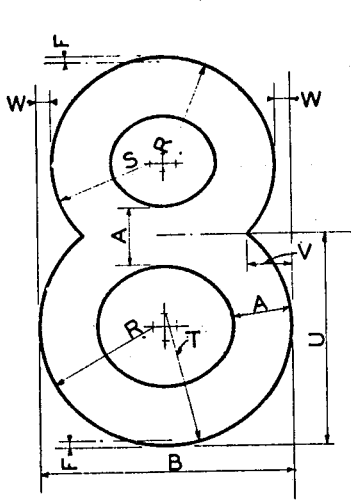
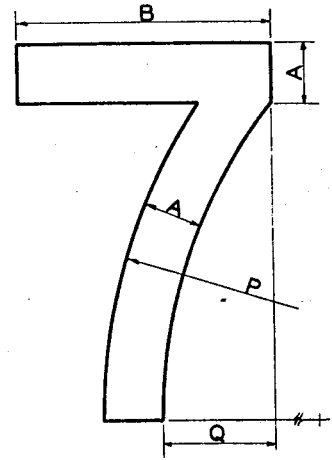
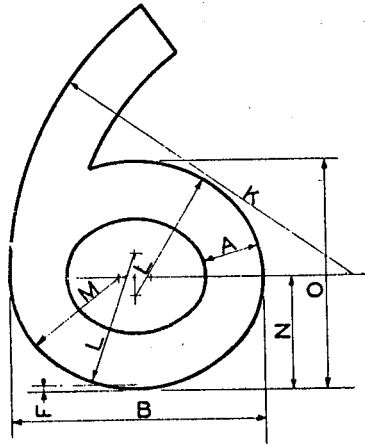
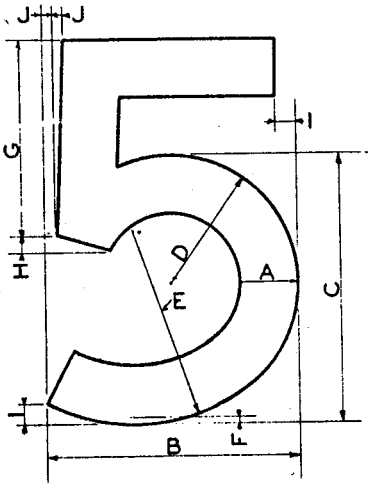

### SERIES D NUMERALS

HEIGHT (INCHES)	DIMENSIONS (INCHES)																									
	A	B	C	D	E	F	G	H	I	J	K	L	M	N	O	P	Q	R	S	T	U	V	W	X	Y	Z
2	1/8	1/32	1/16	3/32	1/64	1/32	1/32	7/64	3/64	1/32	3/32	3/32	3/32	3/32	1/32	3	1/32	3/32	3/32	1/16	1/16	5/64	5/64	1/32	2	3/64
3	1/8	2/64	2/32	1/16	1/32	3/64	1/32	5/64	1/16	2/32	1/16	3/32	3/32	3/32	1/32	4 1/2	3/32	3/32	3/32	1/32	1/16	5/32	7/64	2/64	3	3/64
4	1/8	2/16	2/8	1/32	2/32	1/16	2/16	1/8	3/32	3/32	3/16	1/16	1/32	1/32	2/16	6	1/16	1/32	1/32	1/16	2/4	5/32	5/32	2/16	4	1/32
5	3/32	3/64	3/32	1/32	2/32	5/64	2/32	1/16	1/16	4/32	1/16	1/16	1/16	3/32	7/2	1/16	1/32	1/32	1/32	2/16	3/32	5/64	1/16	3/2	5	1/32
6	1/8	4/32	4/16	2/64	3/64	3/32	3/32	3/16	3/16	5/16	2/32	1/16	1/32	3/32	9	1/32	1/32	1/32	2/16	3/8	5/32	5/64	4/32	6	1/32	
7	1/32	4/64	5/32	2/32	3/64	7/64	3/32	3/16	3/16	6/16	2/32	2/64	2/16	4/16	10 1/2	2/64	2/16	1/16	2/32	3/16	1/16	1/16	17/64	4/32	7	2/64
8	1/4	5/8	5/4	2/16	4/16	1/8	4/8	3/16	7/16	1/8	7/8	2/8	2/16	4/8	12	2/8	2/16	2/16	2/4	4/2	1/8	1/8	5/8	8	2/8	
12	1/8	8/16	8/8	4/32	6/32	3/16	6/16	3/8	3/2	10/16	4/8	3/32	3/32	7/16	18	3/16	3/32	3/32	4/8	6/4	1/32	1/32	8/16	12	3/32	
18	2/16	12/32	12/16	6/16	9/32	3/8	9/32	3/2	1	7/8	16/32	6/32	5/16	5/16	10/32	27	5/16	5/2	4/8	6/16	10/8	2/8	1/16	12/32	18	5/4

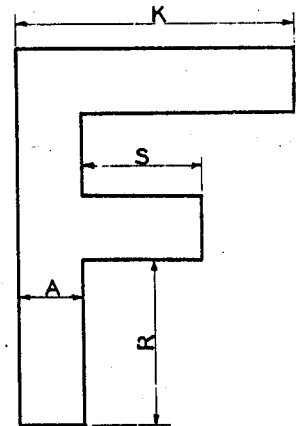
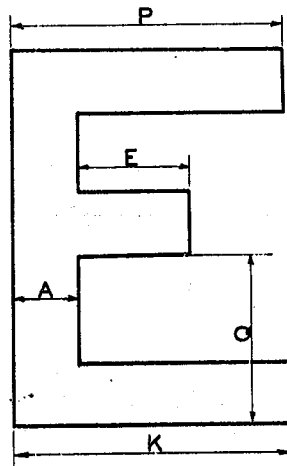
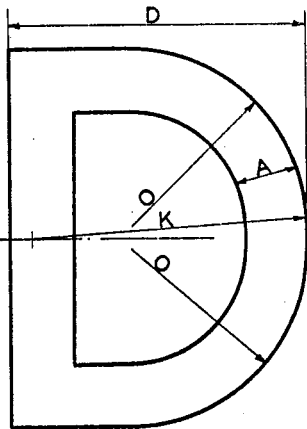
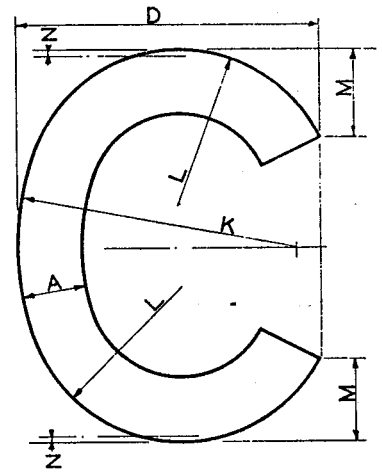
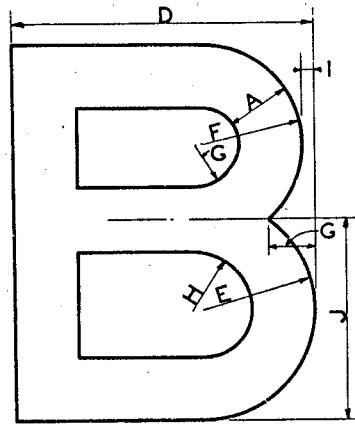
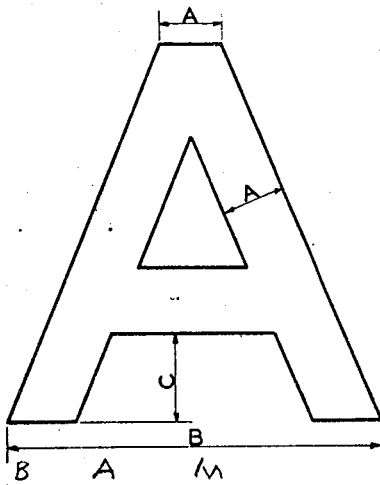

### SERIES E LETTERS

HEIGHT (INCHES)	DIMENSIONS (INCHES)																		
	A	B	C	D	E	F	G	H	I	J	K	L	M	N	O	P	Q	R	S
2	$\frac{11}{32}$	2	$\frac{15}{32}$	$\frac{19}{32}$	$\frac{19}{32}$	$\frac{17}{32}$	$\frac{1}{4}$	$\frac{5}{16}$	$\frac{1}{16}$	$\frac{1}{16}$	$\frac{11}{32}$	$\frac{53}{64}$	$\frac{7}{16}$	$\frac{1}{32}$	$\frac{15}{16}$	$\frac{17}{16}$	$\frac{29}{32}$	$\frac{7}{8}$	$\frac{5}{8}$
3	$\frac{33}{64}$	3	$\frac{45}{64}$	$\frac{225}{64}$	$\frac{57}{64}$	$\frac{51}{64}$	$\frac{3}{8}$	$\frac{15}{32}$	$\frac{3}{32}$	$\frac{19}{32}$	$\frac{213}{64}$	$\frac{155}{64}$	$\frac{21}{32}$	$\frac{3}{64}$	$\frac{11}{32}$	$\frac{25}{32}$	$\frac{123}{64}$	$\frac{15}{16}$	$\frac{15}{16}$
4	$\frac{11}{16}$	4	$\frac{15}{16}$	$\frac{33}{16}$	$\frac{15}{16}$	$\frac{11}{16}$	$\frac{1}{2}$	$\frac{5}{8}$	$\frac{1}{8}$	$\frac{2}{8}$	$\frac{215}{16}$	$\frac{121}{16}$	$\frac{7}{8}$	$\frac{1}{16}$	$\frac{17}{16}$	$\frac{27}{8}$	$\frac{113}{16}$	$\frac{3}{4}$	$\frac{1}{4}$
5	$\frac{25}{64}$	5	$\frac{11}{64}$	$\frac{323}{64}$	$\frac{121}{64}$	$\frac{21}{64}$	$\frac{5}{8}$	$\frac{25}{32}$	$\frac{5}{32}$	$\frac{221}{32}$	$\frac{343}{64}$	$\frac{21}{16}$	$\frac{1}{32}$	$\frac{5}{64}$	$\frac{23}{32}$	$\frac{319}{64}$	$\frac{217}{64}$	$\frac{23}{16}$	$\frac{9}{16}$
6	$\frac{13}{32}$	6	$\frac{13}{32}$	$\frac{425}{32}$	$\frac{125}{32}$	$\frac{119}{32}$	$\frac{3}{4}$	$\frac{15}{16}$	$\frac{3}{16}$	$\frac{33}{16}$	$\frac{413}{32}$	$\frac{231}{64}$	$\frac{5}{16}$	$\frac{3}{32}$	$\frac{213}{16}$	$\frac{225}{16}$	$\frac{223}{32}$	$\frac{25}{8}$	$\frac{17}{8}$
7	$\frac{13}{64}$	7	$\frac{141}{64}$	$\frac{537}{64}$	$\frac{25}{64}$	$\frac{155}{64}$	$\frac{7}{8}$	$\frac{3}{32}$	$\frac{7}{32}$	$\frac{323}{32}$	$\frac{529}{64}$	$\frac{227}{64}$	$\frac{17}{32}$	$\frac{7}{64}$	$\frac{33}{32}$	$\frac{511}{64}$	$\frac{311}{64}$	$\frac{31}{16}$	$\frac{23}{16}$
8	$\frac{1}{8}$	8	$\frac{1}{8}$	$\frac{63}{8}$	$\frac{23}{8}$	$\frac{25}{8}$	1	$\frac{1}{4}$	$\frac{1}{4}$	$\frac{1}{4}$	$\frac{57}{8}$	$\frac{35}{16}$	$\frac{13}{4}$	$\frac{1}{8}$	$\frac{33}{4}$	$\frac{53}{8}$	$\frac{35}{8}$	$\frac{31}{2}$	$\frac{21}{2}$
12	$\frac{21}{16}$	12	$\frac{213}{16}$	$\frac{915}{16}$	$\frac{315}{16}$	$\frac{315}{16}$	$\frac{11}{2}$	$\frac{7}{8}$	$\frac{3}{8}$	$\frac{63}{8}$	$\frac{813}{16}$	$\frac{431}{32}$	$\frac{25}{8}$	$\frac{3}{16}$	$\frac{55}{8}$	$\frac{85}{16}$	$\frac{57}{16}$	$\frac{51}{4}$	$\frac{33}{4}$
18	$\frac{35}{32}$	18	$\frac{43}{32}$	$\frac{1411}{32}$	$\frac{511}{32}$	$\frac{452}{32}$	$\frac{21}{4}$	$\frac{213}{16}$	$\frac{9}{16}$	$\frac{9}{16}$	$\frac{137}{32}$	$\frac{729}{64}$	$\frac{315}{16}$	$\frac{15}{32}$	$\frac{87}{16}$	$\frac{1215}{64}$	$\frac{853}{64}$	$\frac{75}{8}$	$\frac{55}{8}$

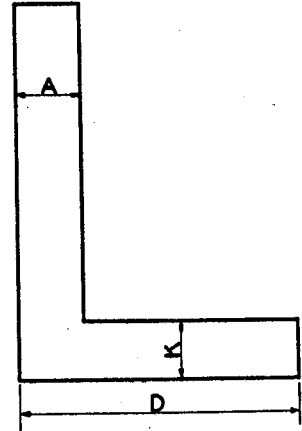
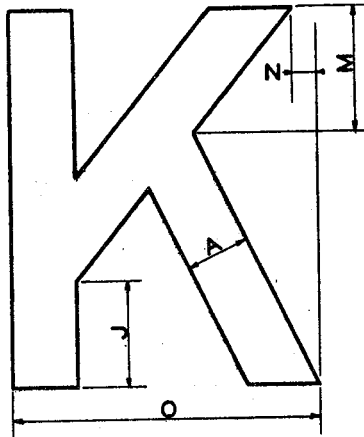
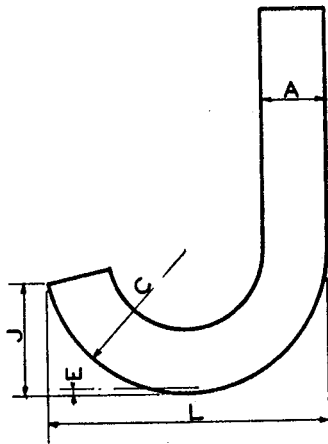
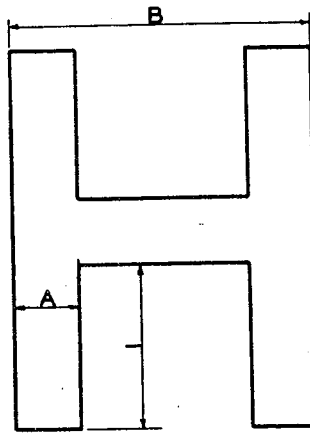
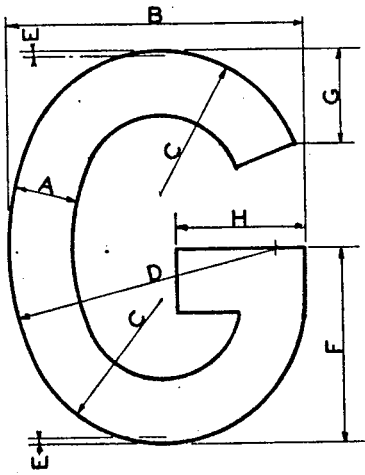

### SERIES E LETTERS

HEIGHT (INCHES)	DIMENSIONS (INCHES)														
	A	B	C	D	E	F	G	H	I	J	K	L	M	N	O
2	$\frac{1}{32}$	$\frac{13}{32}$	$\frac{23}{64}$	$1\frac{13}{32}$	$\frac{1}{32}$	$1\frac{1}{32}$	$\frac{1}{2}$	$\frac{1}{16}$	$\frac{7}{16}$	$\frac{9}{16}$	$\frac{1}{16}$	$1\frac{1}{2}$	$\frac{31}{32}$	$\frac{1}{8}$	$1\frac{1}{8}$
3	$\frac{3}{32}$	$2\frac{25}{64}$	$1\frac{9}{64}$	$2\frac{13}{64}$	$\frac{3}{16}$	$1\frac{25}{64}$	$\frac{3}{4}$	$1\frac{1}{32}$	$1\frac{1}{16}$	$2\frac{7}{32}$	$\frac{13}{32}$	$2\frac{1}{4}$	$\frac{27}{64}$	$\frac{3}{16}$	$2\frac{7}{16}$
4	$\frac{1}{16}$	$3\frac{3}{16}$	$1\frac{17}{32}$	$2\frac{1}{16}$	$\frac{1}{16}$	$2\frac{1}{16}$	1	$1\frac{3}{8}$	$1\frac{3}{4}$	$1\frac{1}{2}$	$\frac{5}{8}$	3	$1\frac{1}{16}$	$\frac{1}{4}$	$3\frac{1}{4}$
5	$\frac{25}{64}$	$3\frac{23}{64}$	$1\frac{29}{64}$	$3\frac{23}{64}$	$\frac{3}{16}$	$2\frac{27}{64}$	$1\frac{1}{4}$	$1\frac{13}{32}$	$2\frac{3}{16}$	$1\frac{13}{32}$	$\frac{25}{32}$	$3\frac{3}{4}$	$1\frac{41}{64}$	$\frac{1}{8}$	$4\frac{1}{16}$
6	$1\frac{1}{32}$	$4\frac{25}{32}$	$2\frac{19}{64}$	$4\frac{13}{32}$	$\frac{5}{32}$	$3\frac{3}{32}$	$1\frac{1}{2}$	$2\frac{1}{16}$	$2\frac{5}{8}$	$1\frac{1}{16}$	$\frac{15}{16}$	$4\frac{1}{2}$	$1\frac{31}{32}$	$\frac{3}{8}$	$4\frac{7}{8}$
7	$1\frac{13}{64}$	$5\frac{27}{64}$	$2\frac{23}{64}$	$5\frac{23}{64}$	$\frac{7}{64}$	$3\frac{29}{64}$	$1\frac{3}{4}$	$2\frac{13}{32}$	$3\frac{1}{16}$	$1\frac{31}{32}$	$1\frac{3}{8}$	$5\frac{1}{4}$	$2\frac{19}{64}$	$\frac{7}{16}$	$5\frac{11}{16}$
8	$1\frac{3}{8}$	$6\frac{3}{8}$	$3\frac{1}{16}$	$5\frac{7}{8}$	$\frac{1}{8}$	$4\frac{1}{8}$	2	$2\frac{3}{4}$	$3\frac{1}{2}$	$2\frac{1}{4}$	$1\frac{1}{2}$	6	$2\frac{5}{8}$	$\frac{1}{2}$	$6\frac{1}{2}$
12	$2\frac{1}{16}$	$9\frac{9}{16}$	$4\frac{13}{32}$	$8\frac{13}{16}$	$\frac{3}{16}$	$6\frac{3}{16}$	5	$4\frac{1}{8}$	$5\frac{1}{4}$	$3\frac{3}{8}$	$1\frac{7}{8}$	9	$3\frac{1}{16}$	$\frac{3}{4}$	$9\frac{3}{8}$
18	$3\frac{3}{32}$	$14\frac{11}{32}$	$6\frac{27}{64}$	$13\frac{7}{32}$	$\frac{3}{32}$	$9\frac{9}{32}$	$4\frac{1}{2}$	$6\frac{1}{16}$	$7\frac{7}{8}$	$5\frac{1}{8}$	$2\frac{11}{16}$	$13\frac{1}{2}$	$5\frac{29}{32}$	$1\frac{1}{8}$	$14\frac{1}{8}$

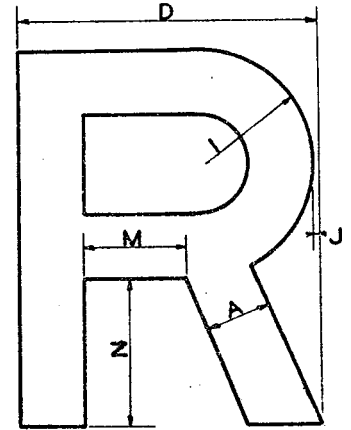
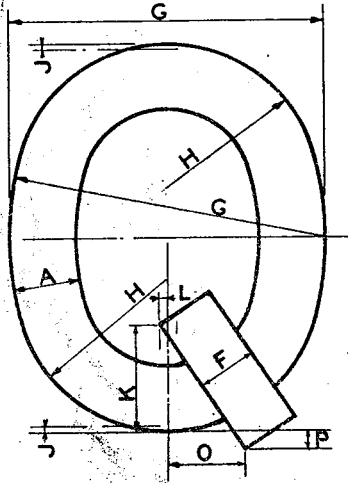
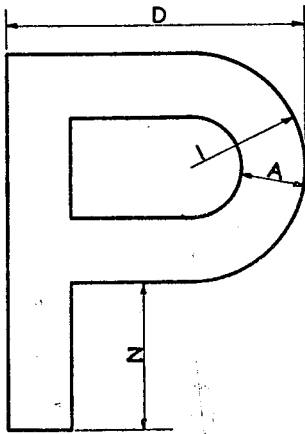
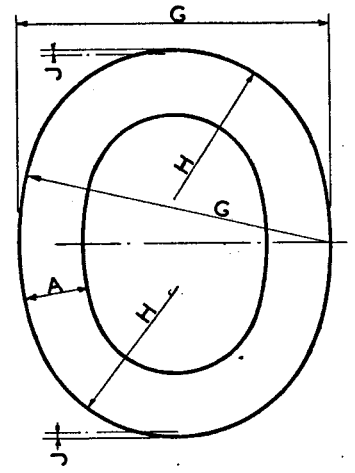
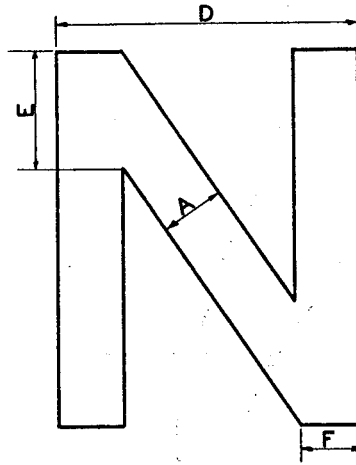
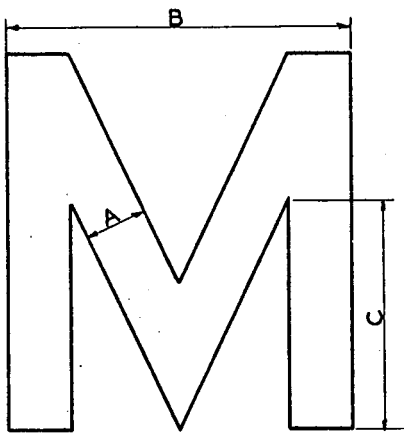

### SERIES E LETTERS

HEIGHT (INCHES)	DIMENSIONS (INCHES)															
	A	B	C	D	E	F	G	H	I	J	K	L	M	N	O	P
2	$\frac{1}{32}$	$\frac{137}{64}$	$\frac{1}{2}$	$\frac{13}{16}$	$\frac{3}{8}$	$\frac{1}{16}$	$\frac{131}{32}$	$\frac{24}{64}$	$\frac{29}{64}$	$\frac{1}{32}$	$\frac{9}{16}$	$\frac{3}{64}$	$\frac{17}{32}$	$\frac{25}{32}$	$\frac{13}{32}$	$\frac{3}{32}$
3	$\frac{33}{64}$	$\frac{223}{64}$	$\frac{33}{64}$	$\frac{223}{64}$	$\frac{13}{16}$	$\frac{15}{32}$	$\frac{231}{64}$	$\frac{13}{16}$	$\frac{29}{32}$	$\frac{3}{64}$	$\frac{21}{32}$	$\frac{1}{16}$	$\frac{21}{64}$	$\frac{11}{16}$	$\frac{39}{64}$	$\frac{9}{64}$
4	$\frac{1}{16}$	$\frac{31}{16}$	$\frac{2}{16}$	$\frac{33}{16}$	$\frac{1}{4}$	$\frac{5}{8}$	$\frac{31}{16}$	$\frac{132}{32}$	$\frac{132}{32}$	$\frac{1}{16}$	$\frac{1}{8}$	$\frac{3}{32}$	$\frac{1}{16}$	$\frac{1}{16}$	$\frac{13}{16}$	$\frac{1}{16}$
5	$\frac{5}{64}$	$\frac{423}{64}$	$\frac{33}{64}$	$\frac{33}{64}$	$\frac{1}{16}$	$\frac{25}{32}$	$\frac{43}{64}$	$\frac{163}{64}$	$\frac{23}{64}$	$\frac{5}{64}$	$\frac{132}{32}$	$\frac{7}{64}$	$\frac{21}{64}$	$\frac{181}{64}$	$\frac{1}{64}$	$\frac{15}{64}$
6	$\frac{1}{32}$	$\frac{517}{64}$	$\frac{33}{32}$	$\frac{423}{64}$	$\frac{1}{8}$	$\frac{15}{16}$	$\frac{431}{64}$	$\frac{2}{32}$	$\frac{163}{64}$	$\frac{3}{32}$	$\frac{1}{16}$	$\frac{9}{64}$	$\frac{19}{32}$	$\frac{21}{32}$	$\frac{17}{32}$	$\frac{9}{32}$
7	$\frac{13}{64}$	$\frac{623}{64}$	$\frac{417}{64}$	$\frac{517}{64}$	$\frac{2}{16}$	$\frac{1}{32}$	$\frac{521}{64}$	$\frac{232}{64}$	$\frac{2}{8}$	$\frac{7}{64}$	$\frac{132}{32}$	$\frac{5}{32}$	$\frac{181}{64}$	$\frac{2}{32}$	$\frac{171}{64}$	$\frac{21}{64}$
8	$\frac{1}{8}$	$\frac{73}{8}$	$\frac{4}{8}$	$\frac{63}{8}$	$2\frac{1}{2}$	$\frac{1}{4}$	$\frac{63}{8}$	$\frac{3}{16}$	$\frac{27}{16}$	$\frac{1}{8}$	$2\frac{1}{4}$	$\frac{3}{16}$	$2\frac{1}{8}$	$\frac{3}{8}$	$\frac{1}{8}$	$\frac{3}{8}$
12	$\frac{2}{16}$	$\frac{11}{16}$	$\frac{7}{16}$	$\frac{9}{16}$	$\frac{3}{4}$	$\frac{1}{8}$	$\frac{9}{16}$	$\frac{432}{32}$	$\frac{321}{32}$	$\frac{3}{16}$	$\frac{3}{8}$	$\frac{9}{32}$	$\frac{3}{16}$	$\frac{41}{16}$	$\frac{2}{16}$	$\frac{9}{16}$
18	$\frac{3}{32}$	$\frac{1619}{64}$	$\frac{1031}{64}$	$\frac{1431}{64}$	$\frac{5}{8}$	$\frac{213}{16}$	$\frac{1429}{64}$	$\frac{711}{64}$	$\frac{5}{2}$	$\frac{9}{32}$	$\frac{5}{16}$	$\frac{7}{16}$	$\frac{425}{64}$	$\frac{7}{32}$	$\frac{321}{64}$	$\frac{27}{32}$

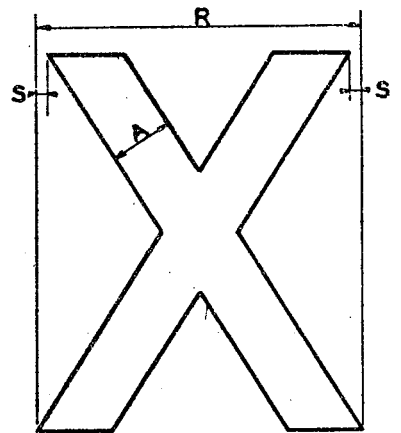
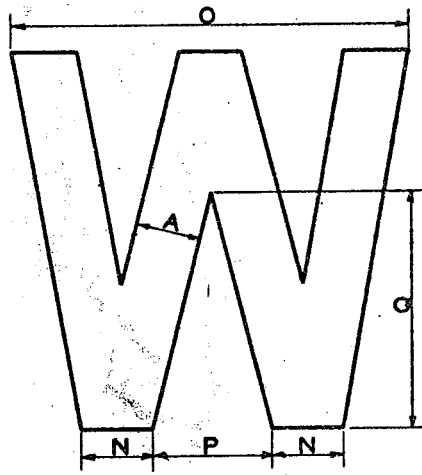
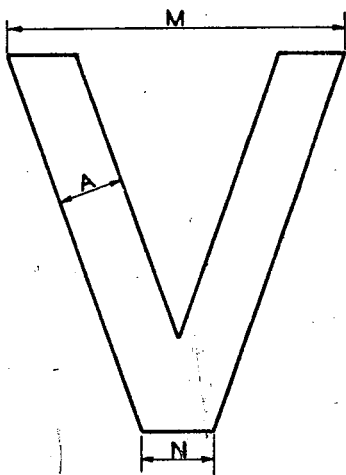
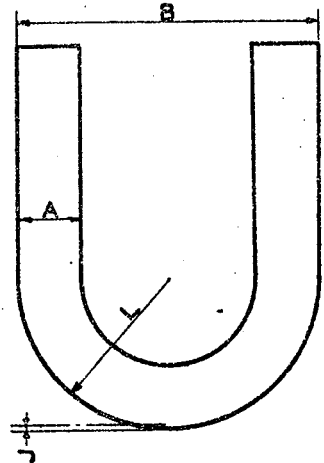
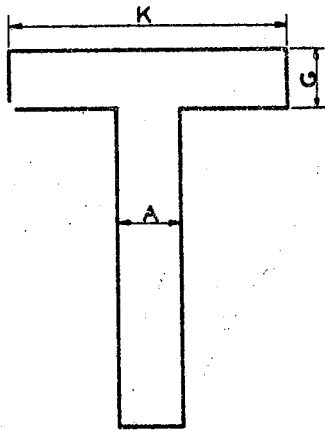
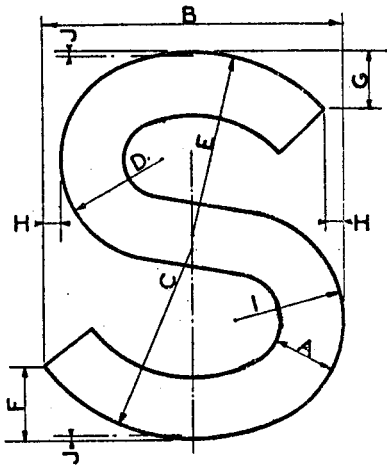

### SERIES E LETTERS

HEIGHT (INCHES)	DIMENSIONS (INCHES)																		
	A	B	C	D	E	F	G	H	I	J	K	L	M	N	O	P	Q	R	S
2	$\frac{11}{32}$	$\frac{19}{32}$	1	$\frac{17}{32}$	$\frac{31}{32}$	$\frac{25}{64}$	$\frac{5}{16}$	$\frac{3}{32}$	$\frac{27}{64}$	$\frac{1}{32}$	$\frac{15}{32}$	$\frac{21}{64}$	$\frac{11}{16}$	$\frac{3}{8}$	$2\frac{3}{32}$	$\frac{3}{8}$	$\frac{1}{4}$	$\frac{123}{32}$	$\frac{1}{16}$
3	$\frac{33}{64}$	$2\frac{25}{64}$	$1\frac{1}{2}$	$\frac{21}{64}$	$\frac{129}{64}$	$\frac{37}{64}$	$\frac{15}{32}$	$\frac{9}{64}$	$\frac{55}{64}$	$\frac{3}{64}$	$2\frac{13}{64}$	$\frac{1}{16}$	$2\frac{23}{32}$	$\frac{9}{16}$	$3\frac{3}{64}$	$\frac{15}{16}$	$1\frac{7}{8}$	$2\frac{27}{64}$	$\frac{3}{32}$
4	$\frac{11}{16}$	$3\frac{7}{16}$	2	$\frac{1}{16}$	$\frac{115}{16}$	$\frac{25}{32}$	$\frac{5}{8}$	$\frac{7}{16}$	$\frac{1}{32}$	$\frac{1}{16}$	$2\frac{15}{16}$	$\frac{119}{32}$	$3\frac{5}{8}$	$\frac{7}{4}$	$4\frac{3}{16}$	$\frac{1}{4}$	$2\frac{1}{2}$	$3\frac{7}{16}$	$\frac{1}{8}$
5	$\frac{25}{64}$	$3\frac{23}{64}$	$2\frac{1}{2}$	$\frac{121}{64}$	$2\frac{27}{64}$	$\frac{31}{32}$	$\frac{27}{64}$	$\frac{13}{16}$	$\frac{1}{16}$	$\frac{5}{64}$	$3\frac{23}{64}$	$\frac{123}{64}$	$4\frac{17}{32}$	$\frac{15}{16}$	$5\frac{15}{64}$	$\frac{1}{16}$	$3\frac{1}{8}$	$4\frac{15}{64}$	$\frac{5}{32}$
6	$\frac{1}{32}$	$4\frac{25}{64}$	3	$\frac{119}{32}$	$2\frac{29}{32}$	$\frac{11}{64}$	$\frac{15}{16}$	$\frac{9}{32}$	$\frac{127}{64}$	$\frac{3}{32}$	$4\frac{13}{32}$	$2\frac{25}{64}$	$5\frac{7}{16}$	$\frac{1}{8}$	$6\frac{3}{32}$	$\frac{1}{16}$	$3\frac{3}{4}$	$5\frac{5}{32}$	$\frac{1}{16}$
7	$\frac{13}{64}$	$5\frac{27}{64}$	$3\frac{1}{2}$	$\frac{125}{64}$	$3\frac{25}{64}$	$\frac{123}{64}$	$\frac{1}{32}$	$\frac{21}{64}$	$2\frac{1}{64}$	$\frac{7}{64}$	$5\frac{2}{64}$	$2\frac{25}{32}$	$6\frac{11}{16}$	$\frac{1}{16}$	$7\frac{21}{64}$	$2\frac{3}{16}$	$4\frac{3}{8}$	$6\frac{1}{64}$	$\frac{7}{32}$
8	$1\frac{3}{8}$	$6\frac{3}{8}$	4	$2\frac{5}{8}$	$3\frac{7}{8}$	$1\frac{9}{16}$	$\frac{1}{4}$	$\frac{3}{8}$	$2\frac{5}{16}$	$\frac{1}{8}$	$5\frac{7}{8}$	$3\frac{1}{16}$	$7\frac{1}{4}$	$\frac{1}{2}$	$8\frac{3}{8}$	$2\frac{1}{2}$	5	$6\frac{3}{8}$	$\frac{1}{4}$
12	$2\frac{1}{16}$	$9\frac{9}{16}$	6	$3\frac{3}{16}$	$5\frac{15}{16}$	$2\frac{1}{32}$	$\frac{1}{8}$	$\frac{9}{16}$	$3\frac{15}{32}$	$\frac{3}{16}$	$8\frac{15}{16}$	$4\frac{25}{32}$	$10\frac{7}{8}$	$2\frac{1}{4}$	$12\frac{9}{16}$	$3\frac{3}{4}$	$7\frac{1}{2}$	$10\frac{15}{16}$	$\frac{3}{8}$
18	$3\frac{3}{32}$	$14\frac{11}{32}$	9	$4\frac{25}{32}$	$8\frac{23}{32}$	$3\frac{1}{2}$	$2\frac{13}{16}$	$\frac{27}{32}$	$5\frac{3}{16}$	$\frac{9}{32}$	$13\frac{7}{32}$	$7\frac{11}{64}$	$16\frac{5}{16}$	$3\frac{3}{8}$	$18\frac{27}{32}$	$5\frac{5}{8}$	$11\frac{1}{4}$	$15\frac{15}{32}$	$\frac{9}{16}$

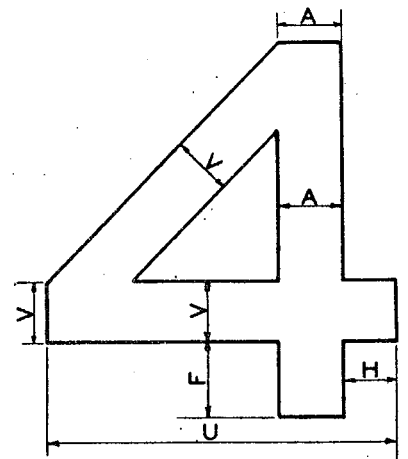
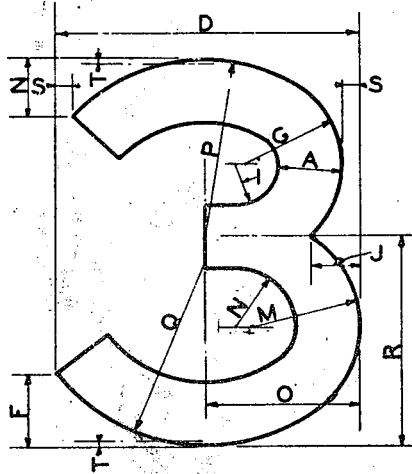
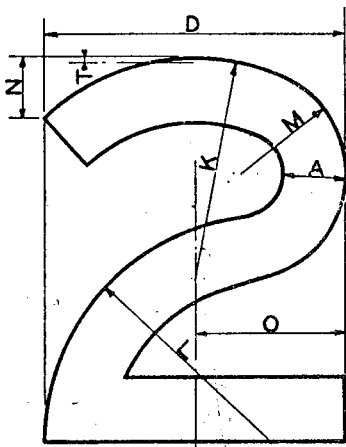
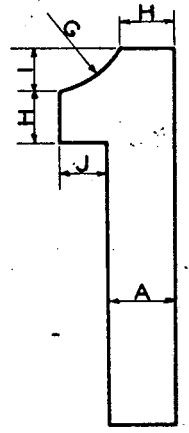
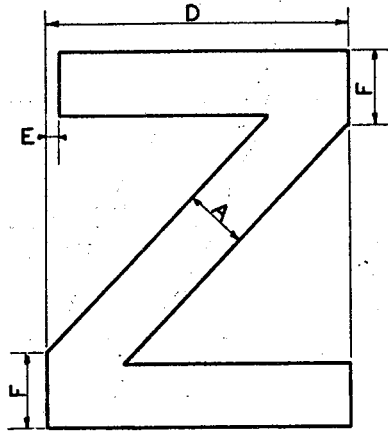
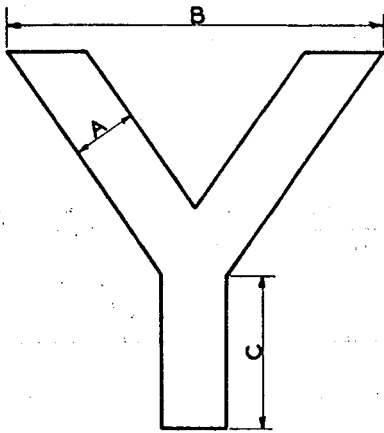

## SERIES E LETTERS AND NUMERALS

HEIGHT (INCHES)	DIMENSIONS (INCHES)																					
	A	B	C	D	E	F	G	H	I	J	K	L	M	N	O	P	Q	R	S	T	U	V
2	$\frac{11}{32}$	2	$\frac{13}{16}$	$\frac{19}{32}$	$\frac{1}{16}$	$\frac{13}{32}$	$\frac{1}{2}$	$\frac{3}{32}$	$\frac{7}{32}$	$\frac{1}{4}$	$\frac{13}{16}$	$\frac{1}{32}$	$\frac{9}{16}$	$\frac{7}{16}$	$\frac{21}{64}$	$\frac{15}{16}$	1	$\frac{1}{8}$	$\frac{3}{32}$	$\frac{1}{32}$	$\frac{127}{64}$	$\frac{21}{64}$
3	$\frac{23}{64}$	3	$\frac{17}{32}$	$\frac{23}{64}$	$\frac{3}{32}$	$\frac{23}{64}$	$\frac{3}{4}$	$\frac{27}{64}$	$\frac{21}{64}$	$\frac{3}{8}$	$\frac{13}{32}$	$\frac{13}{64}$	$\frac{37}{32}$	$\frac{15}{32}$	$\frac{13}{16}$	$\frac{13}{32}$	$\frac{1}{2}$	$\frac{11}{16}$	$\frac{9}{64}$	$\frac{3}{64}$	$\frac{249}{64}$	■
4	$\frac{11}{16}$	4	$\frac{15}{8}$	$\frac{37}{16}$	$\frac{1}{8}$	$\frac{13}{16}$	1	$\frac{9}{16}$	$\frac{7}{16}$	$\frac{1}{2}$	$\frac{23}{8}$	$\frac{27}{16}$	$\frac{1}{8}$	$\frac{9}{8}$	$\frac{13}{16}$	$\frac{17}{8}$	2	$\frac{2}{4}$	$\frac{7}{16}$	$\frac{1}{16}$	$\frac{311}{16}$	$\frac{31}{32}$
5	$\frac{25}{64}$	5	$\frac{21}{32}$	$\frac{35}{64}$	$\frac{5}{32}$	$\frac{15}{64}$	$\frac{1}{4}$	$\frac{23}{64}$	$\frac{35}{64}$	$\frac{5}{8}$	$\frac{23}{32}$	$\frac{37}{64}$	$\frac{13}{32}$	$\frac{25}{32}$	$\frac{15}{64}$	$\frac{21}{32}$	$\frac{2}{2}$	$\frac{21}{16}$	$\frac{15}{64}$	$\frac{3}{64}$	$\frac{423}{64}$	$\frac{13}{16}$
6	$\frac{1}{32}$	6	$\frac{27}{16}$	$\frac{45}{32}$	$\frac{3}{16}$	$\frac{17}{32}$	$\frac{1}{2}$	$\frac{27}{32}$	$\frac{21}{32}$	$\frac{3}{4}$	$\frac{39}{16}$	$\frac{39}{32}$	$\frac{11}{16}$	$\frac{15}{16}$	$\frac{25}{32}$	$\frac{21}{16}$	3	$\frac{3}{8}$	$\frac{3}{32}$	$\frac{3}{32}$	$\frac{517}{32}$	$\frac{63}{64}$
7	$\frac{13}{64}$	7	$\frac{23}{32}$	$\frac{57}{64}$	$\frac{7}{32}$	$\frac{13}{64}$	$\frac{1}{4}$	$\frac{23}{64}$	$\frac{23}{64}$	$\frac{7}{8}$	$\frac{43}{32}$	$\frac{47}{64}$	$\frac{13}{32}$	$\frac{13}{32}$	$\frac{25}{32}$	$\frac{3}{32}$	$\frac{3}{2}$	$\frac{31}{16}$	$\frac{21}{64}$	$\frac{7}{64}$	$\frac{623}{64}$	$\frac{1}{64}$
8	$\frac{1}{8}$	8	$\frac{3}{4}$	$\frac{63}{8}$	$\frac{1}{4}$	$\frac{15}{8}$	2	$\frac{1}{8}$	$\frac{7}{8}$	1	$\frac{43}{4}$	$\frac{47}{8}$	$\frac{2}{4}$	$\frac{1}{4}$	$\frac{39}{16}$	$\frac{3}{4}$	4	$\frac{4}{2}$	$\frac{3}{8}$	$\frac{1}{8}$	$\frac{73}{8}$	$\frac{15}{16}$
12	$\frac{21}{16}$	12	$\frac{47}{8}$	$\frac{99}{16}$	$\frac{3}{8}$	$\frac{27}{16}$	3	$\frac{11}{16}$	$\frac{15}{16}$	$\frac{1}{2}$	$\frac{71}{8}$	$\frac{75}{16}$	$\frac{3}{8}$	$\frac{17}{8}$	$\frac{45}{32}$	$\frac{5}{8}$	6	$\frac{6}{4}$	$\frac{9}{16}$	$\frac{3}{16}$	$\frac{111}{16}$	$\frac{31}{32}$
18	$\frac{33}{32}$	18	$\frac{75}{16}$	$\frac{141}{32}$	$\frac{9}{16}$	$\frac{39}{32}$	$4\frac{1}{2}$	$\frac{217}{32}$	$\frac{131}{32}$	$\frac{2}{4}$	$\frac{101}{16}$	$\frac{105}{32}$	$\frac{5}{16}$	$\frac{213}{16}$	$\frac{75}{32}$	$\frac{67}{16}$	9	$\frac{10}{8}$	$\frac{27}{32}$	$\frac{9}{32}$	$\frac{1613}{32}$	$\frac{215}{16}$

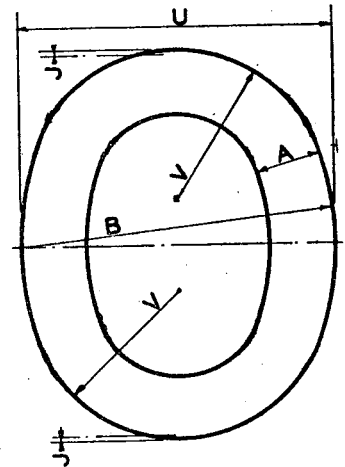
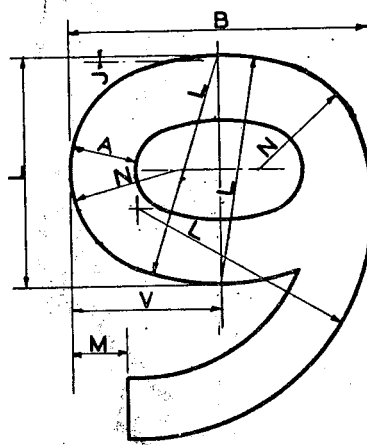
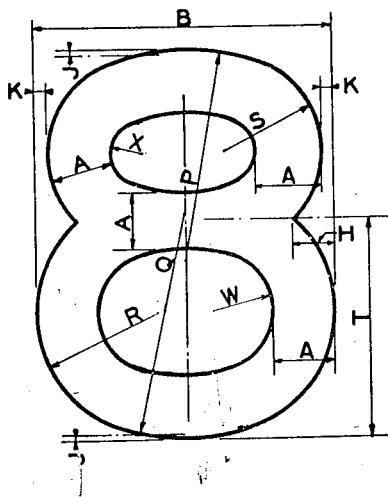
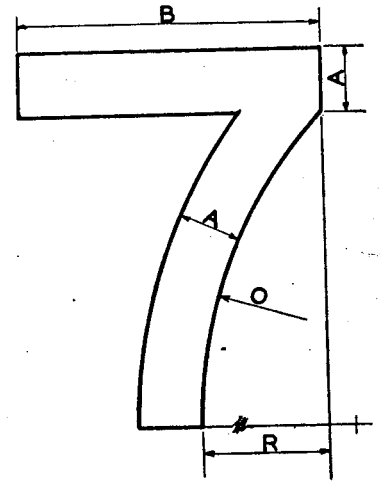
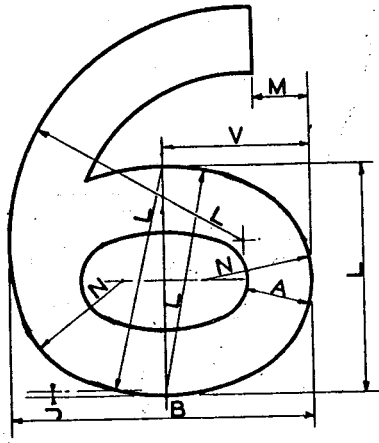
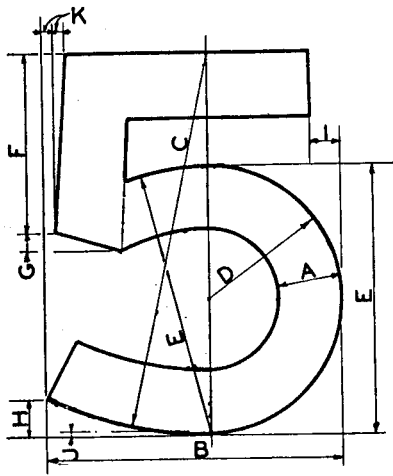

### SERIES E NUMERALS

HEIGHT (INCHES)	DIMENSIONS (INCHES)																							
	A	B	C	D	E	F	G	H	I	J	K	L	M	N	O	P	Q	R	S	T	U	V	W	X
2	$\frac{11}{32}$	$\frac{13}{32}$	$\frac{2}{32}$	$\frac{23}{32}$	$\frac{17}{16}$	$\frac{15}{16}$	$\frac{3}{32}$	$\frac{7}{32}$	$\frac{5}{32}$	$\frac{1}{32}$	$\frac{1}{16}$	$\frac{17}{32}$	$\frac{9}{32}$	$\frac{9}{16}$	$\frac{27}{16}$	$\frac{17}{64}$	$\frac{13}{16}$	$\frac{91}{64}$	$\frac{31}{64}$	$\frac{15}{32}$	$\frac{181}{32}$	$\frac{89}{32}$	$\frac{19}{64}$	$\frac{9}{64}$
3	$\frac{33}{64}$	$\frac{225}{64}$	$\frac{37}{64}$	$\frac{15}{64}$	$\frac{25}{32}$	$\frac{13}{32}$	$\frac{9}{64}$	$\frac{21}{64}$	$\frac{15}{64}$	$\frac{3}{64}$	$\frac{7}{32}$	$\frac{153}{64}$	$\frac{27}{64}$	$\frac{27}{32}$	$\frac{321}{32}$	$\frac{121}{32}$	$\frac{1325}{64}$	$\frac{63}{64}$	$\frac{7}{8}$	$\frac{147}{64}$	$\frac{231}{64}$	$\frac{111}{64}$	$\frac{7}{16}$	$\frac{7}{32}$
4	$\frac{11}{16}$	$\frac{37}{16}$	$\frac{47}{16}$	$\frac{17}{16}$	$\frac{27}{8}$	$\frac{17}{8}$	$\frac{37}{16}$	$\frac{7}{16}$	$\frac{15}{16}$	$\frac{1}{16}$	$\frac{1}{8}$	$\frac{27}{16}$	$\frac{9}{16}$	$\frac{1}{8}$	$\frac{47}{8}$	$\frac{27}{32}$	$\frac{23}{8}$	$\frac{11}{16}$	$\frac{83}{64}$	$\frac{27}{16}$	$\frac{37}{16}$	$\frac{19}{16}$	$\frac{19}{32}$	$\frac{17}{64}$
5	$\frac{25}{64}$	$\frac{323}{64}$	$\frac{57}{64}$	$\frac{51}{64}$	$\frac{39}{32}$	$\frac{211}{32}$	$\frac{35}{64}$	$\frac{25}{64}$	$\frac{5}{64}$	$\frac{3}{32}$	$\frac{37}{64}$	$\frac{47}{64}$	$\frac{153}{32}$	$\frac{63}{32}$	$\frac{233}{32}$	$\frac{231}{32}$	$\frac{121}{64}$	$\frac{183}{64}$	$\frac{27}{64}$	$\frac{27}{64}$	$\frac{49}{64}$	$\frac{181}{64}$	$\frac{47}{64}$	$\frac{23}{64}$
6	$\frac{13}{32}$	$\frac{427}{64}$	$\frac{63}{32}$	$\frac{23}{32}$	$\frac{47}{16}$	$\frac{217}{16}$	$\frac{9}{32}$	$\frac{21}{32}$	$\frac{15}{32}$	$\frac{3}{32}$	$\frac{3}{16}$	$\frac{321}{64}$	$\frac{27}{32}$	$\frac{117}{16}$	$\frac{77}{16}$	$\frac{321}{64}$	$\frac{37}{16}$	$\frac{121}{32}$	$\frac{121}{64}$	$\frac{37}{32}$	$\frac{431}{32}$	$\frac{211}{32}$	$\frac{27}{64}$	$\frac{27}{64}$
7	$\frac{13}{64}$	$\frac{527}{64}$	$\frac{77}{64}$	$\frac{233}{64}$	$\frac{57}{32}$	$\frac{33}{32}$	$\frac{21}{64}$	$\frac{23}{64}$	$\frac{35}{64}$	$\frac{7}{64}$	$\frac{7}{32}$	$\frac{47}{64}$	$\frac{63}{64}$	$\frac{131}{32}$	$\frac{817}{32}$	$\frac{37}{8}$	$\frac{432}{64}$	$\frac{213}{64}$	$\frac{27}{64}$	$\frac{47}{64}$	$\frac{561}{64}$	$\frac{271}{64}$	$\frac{13}{32}$	$\frac{1}{2}$
8	$\frac{13}{8}$	$\frac{637}{8}$	$\frac{87}{8}$	$\frac{27}{8}$	$\frac{57}{4}$	$\frac{37}{4}$	$\frac{37}{8}$	$\frac{7}{8}$	$\frac{9}{8}$	$\frac{1}{8}$	$\frac{1}{4}$	$\frac{47}{8}$	$\frac{11}{8}$	$\frac{21}{4}$	$\frac{97}{4}$	$\frac{47}{16}$	$\frac{43}{4}$	$\frac{25}{8}$	$\frac{183}{64}$	$\frac{47}{8}$	$\frac{637}{8}$	$\frac{37}{8}$	$\frac{13}{16}$	$\frac{17}{32}$
12	$\frac{21}{16}$	$\frac{97}{16}$	$\frac{123}{16}$	$\frac{47}{16}$	$\frac{57}{8}$	$\frac{57}{8}$	$\frac{9}{16}$	$\frac{15}{16}$	$\frac{15}{16}$	$\frac{3}{16}$	$\frac{3}{8}$	$\frac{77}{16}$	$\frac{11}{16}$	$\frac{37}{8}$	$\frac{147}{8}$	$\frac{631}{32}$	$\frac{77}{8}$	$\frac{317}{16}$	$\frac{231}{32}$	$\frac{615}{16}$	$\frac{915}{16}$	$\frac{411}{16}$	$\frac{125}{32}$	$\frac{27}{32}$
18	$\frac{37}{32}$	$\frac{1411}{32}$	$\frac{103}{32}$	$\frac{615}{32}$	$\frac{1215}{16}$	$\frac{67}{16}$	$\frac{27}{32}$	$\frac{131}{32}$	$\frac{113}{32}$	$\frac{9}{32}$	$\frac{9}{16}$	$\frac{1031}{32}$	$\frac{217}{32}$	$\frac{51}{16}$	$\frac{2115}{16}$	$\frac{963}{64}$	$\frac{1011}{16}$	$\frac{529}{32}$	$\frac{429}{64}$	$\frac{1015}{32}$	$\frac{1429}{32}$	$\frac{71}{32}$	$\frac{223}{64}$	$\frac{17}{64}$



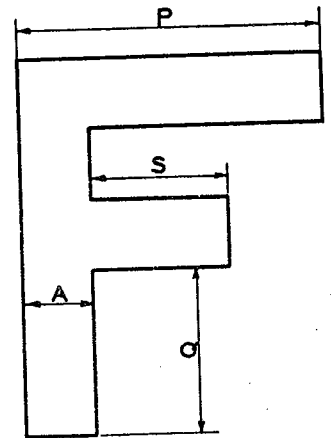
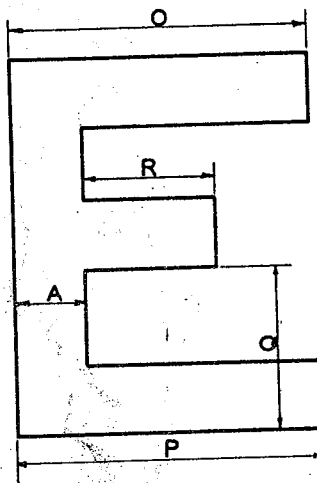
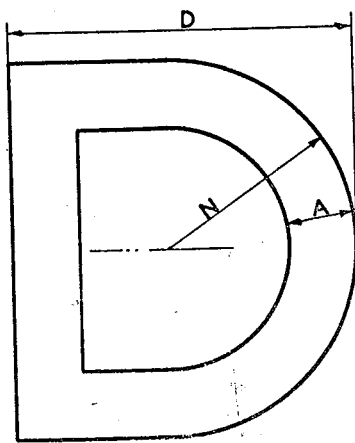
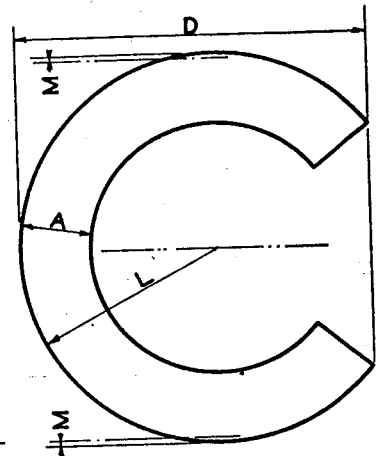
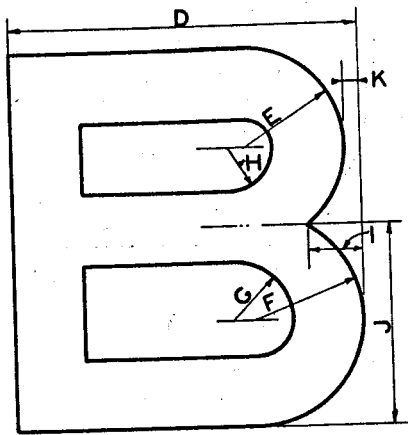
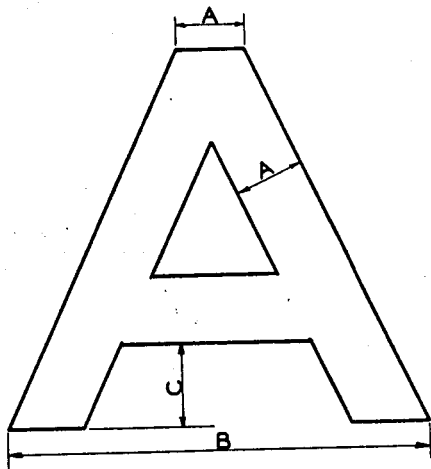

### SERIES F LETTERS

HEIGHT (INCHES)	DIMENSIONS (INCHES)																		
	A	B	C	D	E	F	G	H	I	J	K	L	M	N	O	P	Q	R	S
2	$\frac{3}{8}$	$2\frac{1}{4}$	$\frac{7}{16}$	$1\frac{27}{32}$	$\frac{17}{32}$	$\frac{9}{16}$	$\frac{5}{16}$	$\frac{7}{32}$	$\frac{9}{32}$	$\frac{1}{16}$	$\frac{3}{32}$	$1\frac{1}{32}$	$\frac{1}{2}$	1	$1\frac{9}{16}$	$1\frac{19}{32}$	$\frac{7}{8}$	$\frac{11}{16}$	$\frac{33}{32}$
3	$\frac{9}{16}$	$3\frac{3}{8}$	$\frac{21}{32}$	$2\frac{29}{64}$	$\frac{21}{64}$	$\frac{27}{32}$	$\frac{15}{32}$	$\frac{21}{64}$	$\frac{27}{64}$	$\frac{19}{32}$	$\frac{9}{64}$	$1\frac{35}{64}$	$\frac{3}{4}$	$1\frac{1}{2}$	$2\frac{25}{32}$	$2\frac{25}{32}$	$1\frac{1}{16}$	$1\frac{1}{2}$	$1\frac{5}{8}$
4	$\frac{3}{4}$	$4\frac{1}{2}$	$\frac{7}{8}$	$3\frac{11}{16}$	$1\frac{1}{8}$	$\frac{5}{8}$	$\frac{7}{16}$	$\frac{9}{16}$	$2\frac{1}{2}$	$\frac{7}{8}$	$2\frac{1}{16}$	$2\frac{27}{64}$	$\frac{5}{16}$	2	$3\frac{1}{8}$	$3\frac{3}{16}$	$1\frac{3}{4}$	$1\frac{3}{8}$	$1\frac{7}{8}$
5	$\frac{1}{2}$	$5\frac{5}{8}$	$1\frac{3}{2}$	$4\frac{39}{64}$	$1\frac{21}{64}$	$\frac{13}{32}$	$\frac{25}{32}$	$\frac{25}{64}$	$\frac{25}{64}$	$2\frac{21}{32}$	$\frac{15}{64}$	$2\frac{27}{64}$	$\frac{5}{64}$	$2\frac{1}{2}$	$3\frac{29}{32}$	$3\frac{29}{32}$	$2\frac{3}{16}$	$1\frac{23}{32}$	$1\frac{5}{8}$
6	$1\frac{1}{8}$	$6\frac{3}{4}$	$1\frac{7}{8}$	$5\frac{17}{32}$	$1\frac{19}{32}$	$1\frac{1}{16}$	$\frac{15}{16}$	$\frac{21}{32}$	$\frac{27}{32}$	$3\frac{3}{16}$	$\frac{3}{32}$	$3\frac{3}{32}$	$\frac{3}{32}$	3	$4\frac{1}{16}$	$4\frac{23}{32}$	$2\frac{5}{8}$	$2\frac{1}{16}$	$2\frac{5}{32}$
7	$1\frac{5}{16}$	$7\frac{7}{8}$	$1\frac{17}{32}$	$6\frac{29}{64}$	$1\frac{25}{64}$	$1\frac{3}{32}$	$\frac{15}{32}$	$\frac{23}{64}$	$\frac{23}{64}$	$3\frac{23}{32}$	$\frac{21}{64}$	$3\frac{29}{64}$	$\frac{7}{64}$	$3\frac{1}{2}$	$5\frac{15}{32}$	$5\frac{37}{64}$	$3\frac{1}{16}$	$2\frac{13}{32}$	$2\frac{23}{64}$
8	$1\frac{1}{2}$	9	$1\frac{3}{4}$	$7\frac{3}{8}$	$2\frac{1}{8}$	$2\frac{1}{4}$	$1\frac{1}{4}$	$\frac{7}{8}$	$1\frac{1}{8}$	$4\frac{1}{4}$	$\frac{3}{8}$	$4\frac{1}{8}$	$\frac{1}{8}$	4	$6\frac{1}{4}$	$6\frac{3}{8}$	$3\frac{1}{2}$	$2\frac{3}{4}$	$2\frac{7}{8}$
12	$2\frac{1}{4}$	$13\frac{1}{2}$	$2\frac{5}{8}$	$11\frac{1}{16}$	$3\frac{7}{16}$	$3\frac{3}{8}$	$1\frac{7}{8}$	$1\frac{5}{16}$	$1\frac{11}{16}$	$6\frac{3}{8}$	$\frac{9}{16}$	$6\frac{7}{16}$	$\frac{3}{16}$	6	$9\frac{3}{8}$	$9\frac{1}{16}$	$5\frac{1}{4}$	$4\frac{1}{8}$	$4\frac{1}{16}$
18	$3\frac{3}{8}$	$20\frac{1}{4}$	$3\frac{15}{16}$	$16\frac{19}{32}$	$4\frac{25}{32}$	$5\frac{1}{16}$	$2\frac{13}{16}$	$1\frac{31}{32}$	$2\frac{17}{32}$	$9\frac{3}{16}$	$\frac{27}{32}$	$9\frac{9}{32}$	$\frac{9}{32}$	9	$14\frac{1}{16}$	$14\frac{11}{32}$	$7\frac{3}{8}$	$6\frac{1}{16}$	$6\frac{15}{32}$

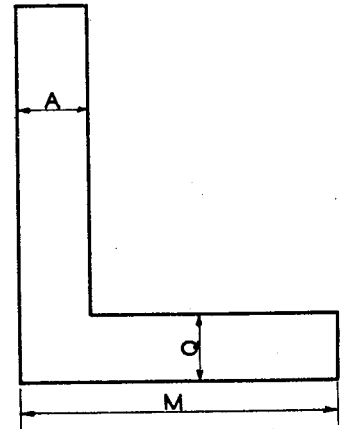
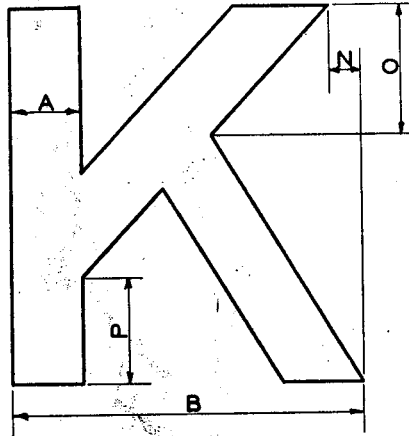
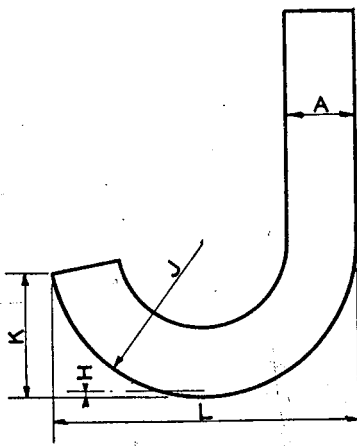
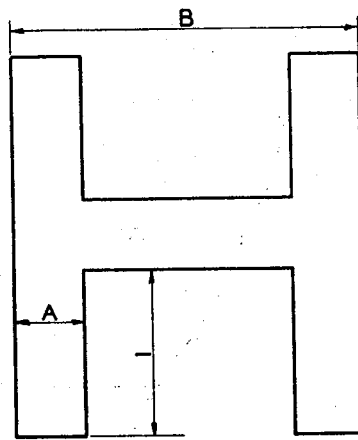
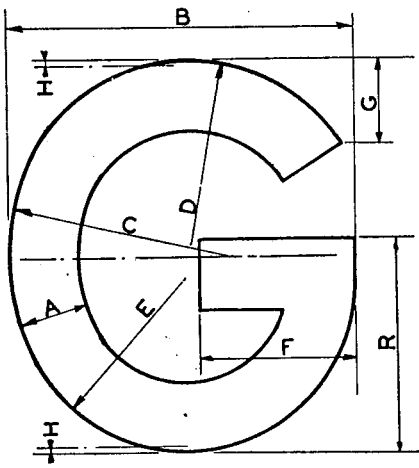

### SERIES F LETTERS

HEIGHT (INCHES)	DIMENSIONS (INCHES)																	
	A	B	C	D	E	F	G	H	I	J	K	L	M	N	O	P	Q	R
2	$\frac{3}{8}$	$\frac{17}{32}$	$\frac{1}{16}$	$\frac{3}{32}$	$\frac{29}{32}$	$\frac{27}{32}$	$\frac{7}{16}$	$\frac{1}{32}$	$\frac{7}{8}$	$\frac{13}{16}$	$\frac{21}{32}$	$\frac{1}{8}$	$\frac{11}{16}$	$\frac{5}{32}$	$\frac{11}{16}$	$\frac{9}{16}$	$\frac{11}{32}$	$\frac{1}{8}$
3	$\frac{3}{16}$	$\frac{23}{64}$	$\frac{123}{64}$	$\frac{123}{64}$	$\frac{123}{64}$	$\frac{17}{64}$	$\frac{21}{32}$	$\frac{3}{64}$	$\frac{1}{16}$	$\frac{7}{32}$	$\frac{63}{64}$	$\frac{2}{16}$	$\frac{27}{32}$	$\frac{15}{64}$	$\frac{1}{32}$	$\frac{27}{32}$	$\frac{33}{64}$	$\frac{1}{16}$
4	$\frac{3}{4}$	$\frac{31}{16}$	$2\frac{3}{8}$	$\frac{115}{16}$	$\frac{113}{16}$	$\frac{111}{16}$	$\frac{7}{8}$	$\frac{1}{16}$	$\frac{1}{4}$	$\frac{1}{8}$	$\frac{15}{16}$	$3\frac{1}{4}$	$3\frac{3}{8}$	$\frac{5}{16}$	$\frac{1}{8}$	$\frac{1}{8}$	$\frac{1}{16}$	$2\frac{1}{4}$
5	$\frac{15}{16}$	$4\frac{39}{64}$	$2\frac{31}{32}$	$\frac{227}{64}$	$\frac{217}{64}$	$\frac{217}{64}$	$\frac{1}{32}$	$\frac{5}{64}$	$2\frac{3}{16}$	$2\frac{1}{32}$	$\frac{141}{64}$	$4\frac{1}{16}$	$4\frac{7}{32}$	$\frac{25}{64}$	$\frac{15}{32}$	$\frac{113}{32}$	$\frac{23}{64}$	$2\frac{1}{16}$
6	$\frac{1}{8}$	$5\frac{17}{32}$	$3\frac{3}{16}$	$\frac{229}{32}$	$\frac{223}{32}$	$\frac{217}{32}$	$\frac{1}{16}$	$\frac{3}{32}$	$2\frac{5}{8}$	$2\frac{7}{16}$	$\frac{31}{32}$	$4\frac{7}{8}$	$5\frac{1}{16}$	$\frac{15}{32}$	$2\frac{1}{16}$	$\frac{11}{16}$	$\frac{1}{32}$	$3\frac{3}{8}$
7	$\frac{1}{16}$	$6\frac{23}{64}$	$4\frac{5}{32}$	$\frac{325}{64}$	$\frac{315}{64}$	$\frac{261}{64}$	$\frac{17}{32}$	$\frac{7}{64}$	$3\frac{1}{16}$	$2\frac{27}{32}$	$\frac{219}{64}$	$5\frac{1}{16}$	$5\frac{23}{64}$	$\frac{35}{64}$	$\frac{23}{32}$	$\frac{31}{32}$	$\frac{13}{64}$	$3\frac{15}{16}$
8	$1\frac{1}{2}$	$7\frac{3}{8}$	$4\frac{3}{4}$	$3\frac{7}{8}$	$3\frac{3}{8}$	$3\frac{3}{8}$	$\frac{1}{4}$	$\frac{1}{8}$	$3\frac{1}{2}$	$3\frac{1}{4}$	$2\frac{5}{8}$	$6\frac{1}{2}$	$6\frac{3}{4}$	$\frac{5}{8}$	$2\frac{3}{4}$	$2\frac{1}{4}$	$\frac{1}{8}$	$4\frac{1}{2}$
12	$2\frac{1}{4}$	$11\frac{1}{16}$	$7\frac{3}{8}$	$5\frac{1}{16}$	$5\frac{7}{16}$	$5\frac{1}{16}$	$2\frac{5}{8}$	$\frac{3}{16}$	$5\frac{1}{4}$	$4\frac{7}{8}$	$3\frac{15}{16}$	$9\frac{3}{4}$	$10\frac{5}{8}$	$\frac{13}{16}$	$4\frac{1}{8}$	$3\frac{3}{8}$	$2\frac{1}{16}$	$6\frac{3}{4}$
18	$3\frac{3}{8}$	$16\frac{19}{32}$	$10\frac{11}{16}$	$8\frac{23}{32}$	$8\frac{5}{16}$	$7\frac{19}{32}$	$3\frac{13}{16}$	$\frac{9}{32}$	$7\frac{7}{8}$	$7\frac{5}{8}$	$5\frac{29}{32}$	$14\frac{3}{8}$	$15\frac{3}{16}$	$\frac{11}{32}$	$6\frac{3}{16}$	$5\frac{1}{16}$	$3\frac{3}{32}$	$10\frac{1}{8}$

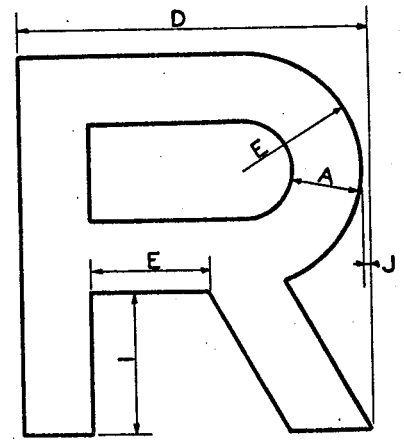
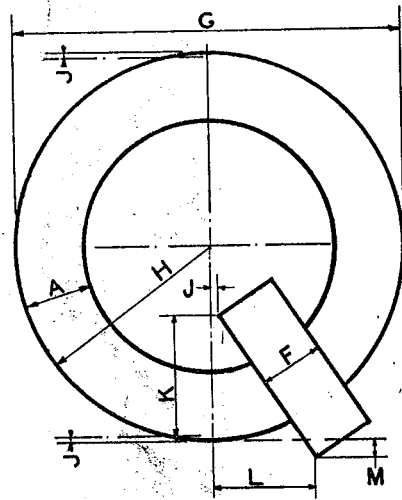
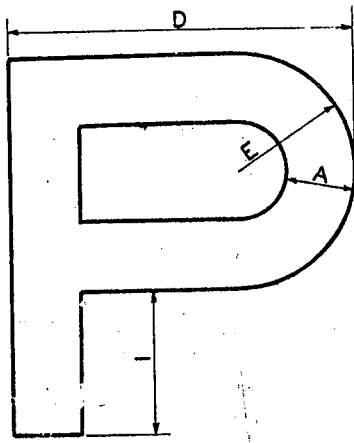
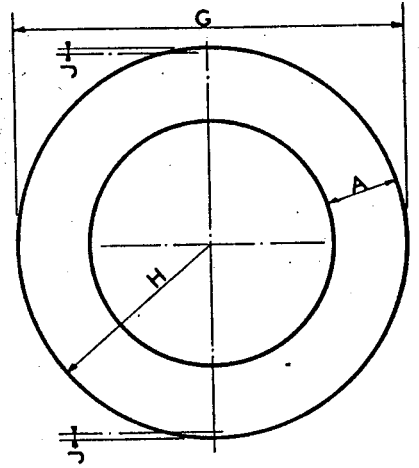
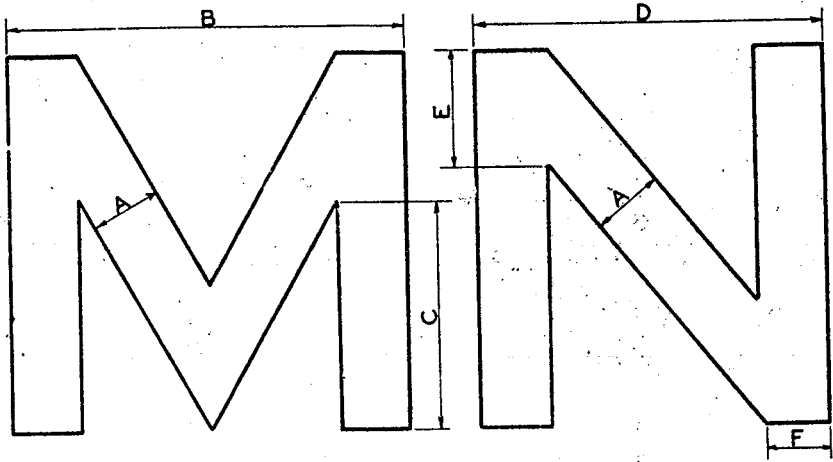

### SERIES F LETTERS

HEIGHT (INCHES)	DIMENSIONS (INCHES)												
	A	B	C	D	E	F	G	H	I	J	K	L	M
2	$\frac{3}{8}$	$2\frac{1}{8}$	$1\frac{3}{16}$	$1\frac{27}{32}$	$\frac{5}{8}$	$\frac{11}{32}$	$2\frac{1}{16}$	$1\frac{1}{32}$	$\frac{3}{4}$	$1\frac{1}{32}$	$\frac{21}{32}$	$\frac{17}{32}$	$\frac{3}{32}$
3	$\frac{9}{16}$	$3\frac{3}{16}$	$1\frac{25}{32}$	$2\frac{49}{64}$	$\frac{15}{16}$	$\frac{23}{64}$	$3\frac{3}{32}$	$1\frac{25}{64}$	$1\frac{1}{8}$	$\frac{3}{64}$	$\frac{63}{64}$	$\frac{51}{64}$	$\frac{9}{64}$
4	$\frac{3}{4}$	$4\frac{1}{4}$	$2\frac{3}{8}$	$3\frac{11}{16}$	$1\frac{1}{4}$	$\frac{11}{16}$	$4\frac{1}{8}$	$2\frac{1}{16}$	$1\frac{1}{2}$	$1\frac{1}{16}$	$1\frac{5}{16}$	$1\frac{1}{16}$	$\frac{3}{16}$
5	$\frac{15}{16}$	$5\frac{5}{16}$	$2\frac{31}{32}$	$4\frac{39}{64}$	$1\frac{9}{16}$	$\frac{25}{64}$	$5\frac{5}{32}$	$2\frac{27}{64}$	$1\frac{7}{8}$	$\frac{5}{64}$	$\frac{11}{64}$	$1\frac{21}{64}$	$\frac{15}{64}$
6	$1\frac{1}{8}$	$6\frac{3}{8}$	$3\frac{9}{16}$	$5\frac{17}{32}$	$1\frac{7}{8}$	$1\frac{1}{32}$	$6\frac{3}{16}$	$3\frac{3}{32}$	$2\frac{1}{4}$	$\frac{3}{32}$	$1\frac{31}{32}$	$1\frac{19}{32}$	$\frac{9}{32}$
7	$1\frac{5}{16}$	$7\frac{1}{16}$	$4\frac{5}{32}$	$6\frac{29}{64}$	$2\frac{7}{16}$	$1\frac{13}{64}$	$7\frac{1}{32}$	$3\frac{29}{64}$	$2\frac{5}{8}$	$\frac{7}{64}$	$2\frac{19}{64}$	$1\frac{55}{64}$	$2\frac{1}{64}$
8	$1\frac{1}{2}$	$8\frac{1}{2}$	$4\frac{3}{4}$	$7\frac{3}{8}$	$2\frac{1}{2}$	$1\frac{3}{8}$	$8\frac{1}{4}$	$4\frac{1}{8}$	3	$\frac{1}{8}$	$2\frac{7}{8}$	$2\frac{1}{8}$	$\frac{3}{8}$
12	$2\frac{1}{4}$	$12\frac{3}{4}$	$7\frac{1}{8}$	$11\frac{1}{16}$	$3\frac{3}{4}$	$2\frac{1}{16}$	$12\frac{3}{8}$	$6\frac{3}{16}$	$4\frac{1}{2}$	$\frac{3}{16}$	$3\frac{15}{16}$	$3\frac{3}{16}$	$\frac{9}{16}$
18	$3\frac{3}{8}$	$18\frac{1}{2}$	$10\frac{11}{16}$	$16\frac{19}{32}$	$5\frac{5}{8}$	$3\frac{3}{32}$	$18\frac{9}{16}$	$9\frac{9}{32}$	$6\frac{3}{4}$	$\frac{9}{32}$	$5\frac{29}{32}$	$4\frac{25}{32}$	$2\frac{27}{32}$

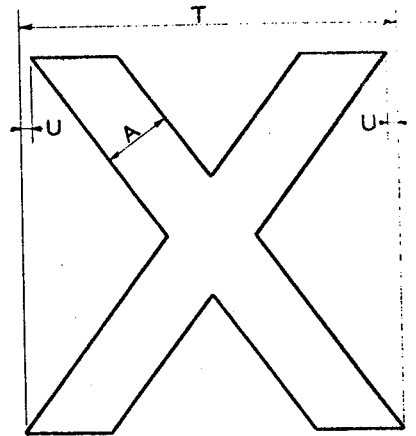
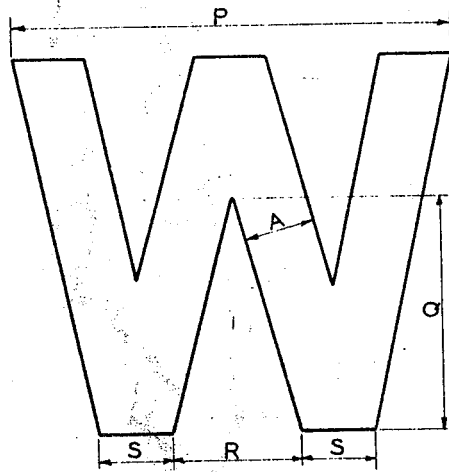
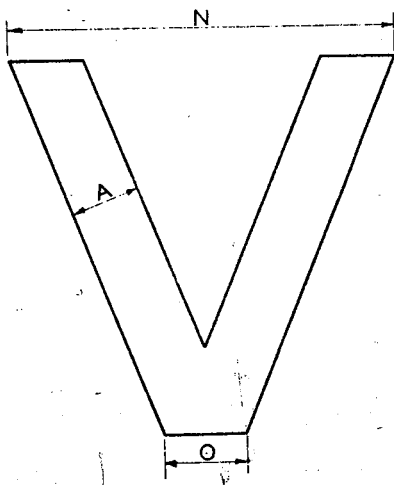
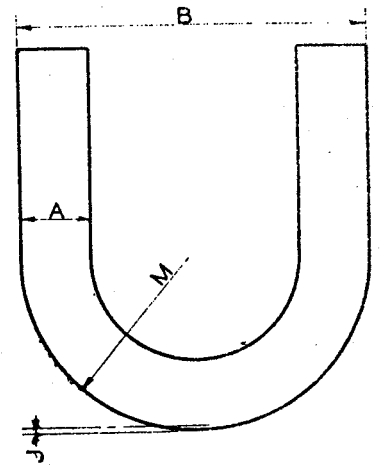
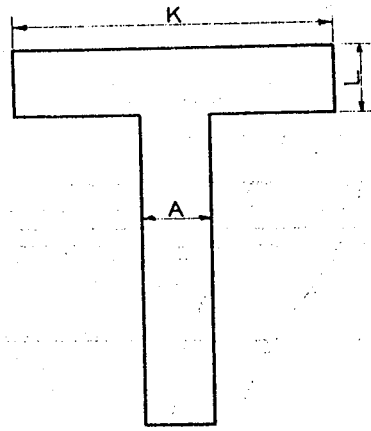
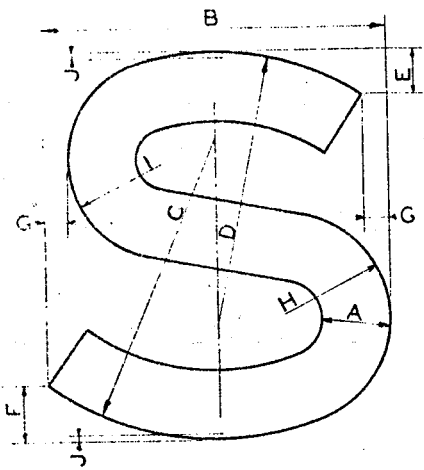

## SERIES F LETTERS

HEIGHT (INCHES)	DIMENSIONS (INCHES)													U							
	A	B	C	D	E	F	G	H	I	J	K	L	M		N	O	P	Q	R	S	T
2	$\frac{3}{8}$	$1\frac{27}{32}$	$1\frac{9}{16}$	$1\frac{7}{16}$	$\frac{15}{64}$	$\frac{19}{64}$	$\frac{1}{8}$	$\frac{9}{16}$	$\frac{17}{32}$	$\frac{1}{32}$	$\frac{11}{16}$	$\frac{11}{32}$	$\frac{59}{64}$	$2\frac{1}{16}$	$\frac{7}{16}$	$2\frac{5}{16}$	$\frac{1}{4}$	$\frac{11}{16}$	$\frac{13}{32}$	2	$\frac{1}{16}$
3	$\frac{9}{16}$	$2\frac{3}{4}$	$2\frac{11}{32}$	$2\frac{5}{32}$	$\frac{11}{32}$	$\frac{7}{16}$	$\frac{3}{16}$	$\frac{27}{32}$	$\frac{51}{64}$	$\frac{3}{64}$	$2\frac{17}{32}$	$\frac{33}{64}$	$1\frac{3}{8}$	$3\frac{3}{32}$	$\frac{21}{32}$	$3\frac{15}{32}$	$1\frac{7}{8}$	$1\frac{1}{32}$	$\frac{39}{64}$	3	$3\frac{3}{32}$
4	$\frac{3}{4}$	$3\frac{11}{16}$	$3\frac{1}{8}$	$2\frac{7}{8}$	$\frac{15}{32}$	$\frac{19}{32}$	$\frac{1}{4}$	$1\frac{1}{8}$	$1\frac{1}{16}$	$\frac{1}{16}$	$3\frac{3}{8}$	$\frac{11}{16}$	$1\frac{27}{32}$	$4\frac{1}{8}$	$\frac{7}{8}$	$4\frac{5}{8}$	$2\frac{1}{2}$	$1\frac{3}{8}$	$\frac{13}{16}$	4	$\frac{1}{8}$
5	$\frac{15}{16}$	$4\frac{19}{32}$	$3\frac{29}{32}$	$3\frac{19}{32}$	$\frac{37}{64}$	$\frac{47}{64}$	$\frac{5}{16}$	$1\frac{13}{32}$	$\frac{21}{64}$	$\frac{5}{64}$	$4\frac{7}{32}$	$\frac{55}{64}$	$2\frac{19}{64}$	$5\frac{5}{32}$	$1\frac{3}{32}$	$5\frac{29}{32}$	$3\frac{1}{8}$	$1\frac{53}{32}$	$1\frac{1}{64}$	5	$5\frac{5}{32}$
6	$1\frac{1}{8}$	$5\frac{17}{32}$	$4\frac{11}{16}$	$4\frac{5}{16}$	$\frac{65}{64}$	$\frac{57}{64}$	$\frac{3}{8}$	$1\frac{11}{16}$	$1\frac{19}{32}$	$\frac{3}{32}$	$5\frac{1}{16}$	$1\frac{1}{32}$	$2\frac{29}{64}$	$6\frac{3}{16}$	$1\frac{5}{16}$	$6\frac{15}{16}$	$3\frac{3}{8}$	$2\frac{1}{16}$	$\frac{7}{32}$	6	$\frac{3}{16}$
7	$1\frac{3}{8}$	$6\frac{7}{16}$	$5\frac{15}{32}$	$5\frac{1}{32}$	$\frac{11}{16}$	$1\frac{1}{32}$	$\frac{7}{16}$	$1\frac{31}{32}$	$1\frac{55}{64}$	$\frac{7}{64}$	$5\frac{29}{32}$	$1\frac{13}{64}$	$3\frac{7}{32}$	$7\frac{7}{32}$	$\frac{17}{32}$	$8\frac{3}{32}$	$4\frac{3}{8}$	$2\frac{13}{32}$	$\frac{127}{64}$	7	$\frac{7}{32}$
8	$1\frac{1}{2}$	$7\frac{3}{8}$	$6\frac{1}{4}$	$5\frac{3}{4}$	$\frac{15}{16}$	$1\frac{1}{16}$	$\frac{1}{2}$	$2\frac{1}{4}$	$2\frac{1}{8}$	$\frac{1}{8}$	$6\frac{3}{4}$	$1\frac{3}{8}$	$3\frac{11}{16}$	$8\frac{1}{4}$	$1\frac{3}{4}$	$9\frac{1}{4}$	$5$	$2\frac{3}{8}$	$1\frac{5}{8}$	8	$\frac{1}{4}$
12	$2\frac{1}{4}$	$11\frac{1}{16}$	$9\frac{3}{8}$	$8\frac{5}{8}$	$1\frac{13}{32}$	$1\frac{25}{32}$	$\frac{3}{4}$	$3\frac{3}{8}$	$3\frac{3}{16}$	$\frac{3}{16}$	$10\frac{1}{8}$	$2\frac{1}{16}$	$5\frac{17}{32}$	$12\frac{3}{8}$	$2\frac{5}{8}$	$13\frac{7}{8}$	$7\frac{1}{2}$	$4\frac{1}{8}$	$2\frac{7}{16}$	12	$\frac{3}{8}$
18	$3\frac{3}{8}$	$16\frac{19}{32}$	$14\frac{1}{16}$	$12\frac{15}{16}$	$2\frac{1}{8}$	$2\frac{11}{16}$	$1\frac{1}{8}$	$5\frac{1}{16}$	$4\frac{29}{32}$	$\frac{9}{32}$	$15\frac{3}{16}$	$3\frac{3}{32}$	$8\frac{19}{64}$	$18\frac{9}{16}$	$3\frac{13}{16}$	$20\frac{13}{16}$	$11\frac{1}{4}$	$6\frac{3}{16}$	$3\frac{21}{32}$	18	$\frac{9}{16}$

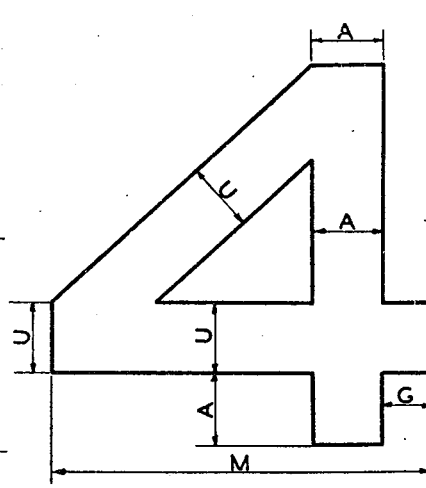
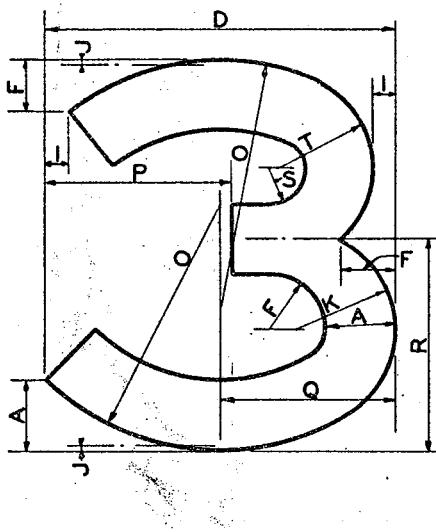
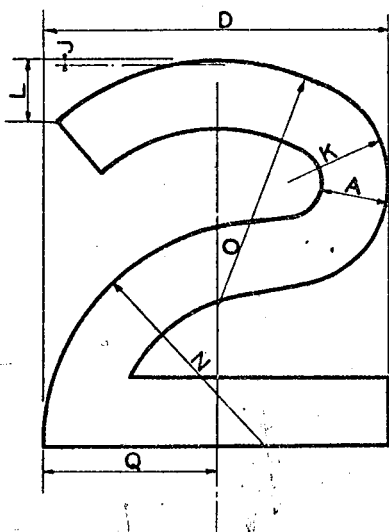
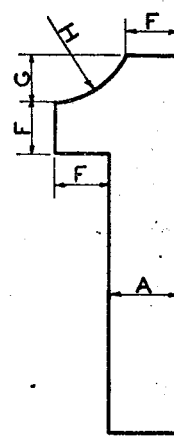
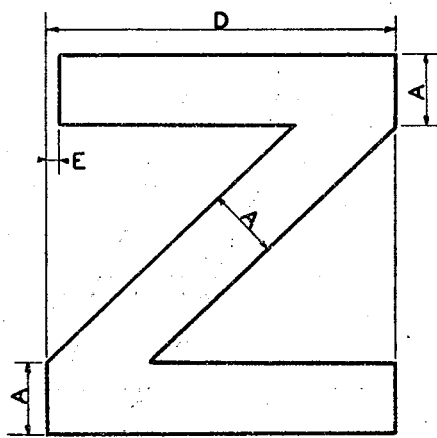
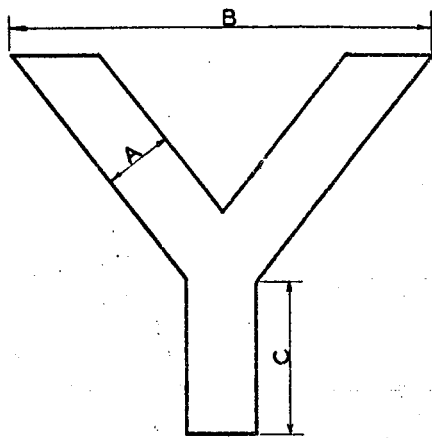

### SERIES F LETTERS AND NUMERALS

HEIGHT (INCHES)	DIMENSIONS (INCHES)																				
	A	B	C	D	E	F	G	H	I	J	K	L	M	N	O	P	Q	R	S	T	U
2	$\frac{3}{8}$	$2\frac{1}{4}$	$\frac{13}{16}$	$\frac{127}{32}$	$\frac{1}{16}$	$\frac{9}{32}$	$\frac{1}{4}$	$\frac{7}{16}$	$\frac{1}{8}$	$\frac{1}{32}$	$\frac{35}{64}$	$\frac{21}{64}$	2	$\frac{13}{16}$	$\frac{15}{16}$	$\frac{31}{32}$	$\frac{59}{64}$	$\frac{1}{8}$	$\frac{3}{16}$	$\frac{1}{2}$	$\frac{23}{64}$
3	$\frac{9}{16}$	$3\frac{3}{8}$	$\frac{1}{2}$	$\frac{249}{64}$	$\frac{3}{32}$	$\frac{23}{64}$	$\frac{3}{8}$	$\frac{21}{32}$	$\frac{3}{16}$	$\frac{3}{64}$	$\frac{13}{16}$	$\frac{31}{64}$	3	$\frac{13}{32}$	$\frac{13}{32}$	$\frac{127}{64}$	$\frac{1}{8}$	$\frac{11}{16}$	$\frac{9}{32}$	$\frac{7}{4}$	$\frac{17}{32}$
4	$\frac{3}{4}$	$4\frac{1}{2}$	$\frac{5}{8}$	$3\frac{11}{16}$	$\frac{1}{8}$	$\frac{9}{16}$	$\frac{1}{2}$	$\frac{7}{8}$	$\frac{1}{4}$	$\frac{1}{16}$	$\frac{33}{32}$	$\frac{51}{32}$	4	$2\frac{3}{8}$	$2\frac{5}{8}$	$\frac{115}{16}$	$\frac{127}{32}$	$2\frac{1}{4}$	$\frac{3}{8}$	1	$\frac{33}{32}$
5	$\frac{15}{16}$	$5\frac{5}{8}$	$2\frac{3}{2}$	$4\frac{39}{64}$	$\frac{5}{32}$	$\frac{45}{64}$	$\frac{5}{8}$	$\frac{13}{32}$	$\frac{5}{16}$	$\frac{5}{64}$	$\frac{23}{64}$	$\frac{13}{16}$	5	$2\frac{31}{32}$	$3\frac{9}{32}$	$\frac{227}{64}$	$\frac{219}{64}$	$2\frac{13}{16}$	$\frac{15}{32}$	$1\frac{1}{4}$	$\frac{57}{64}$
6	$\frac{1}{5}$	$6\frac{3}{4}$	$2\frac{7}{16}$	$5\frac{17}{32}$	$\frac{3}{16}$	$\frac{27}{32}$	$\frac{3}{4}$	$\frac{5}{16}$	$\frac{3}{8}$	$\frac{3}{32}$	$\frac{41}{64}$	$\frac{53}{64}$	6	$3\frac{9}{16}$	$3\frac{15}{16}$	$\frac{229}{32}$	$\frac{249}{64}$	$3\frac{3}{8}$	$\frac{9}{16}$	$1\frac{1}{2}$	$\frac{15}{64}$
7	$\frac{15}{16}$	$7\frac{7}{8}$	$2\frac{27}{32}$	$6\frac{23}{64}$	$\frac{7}{32}$	$\frac{53}{64}$	$\frac{7}{8}$	$\frac{17}{32}$	$\frac{7}{16}$	$\frac{7}{64}$	$\frac{129}{32}$	$\frac{17}{64}$	7	$4\frac{5}{32}$	$4\frac{19}{32}$	$\frac{323}{64}$	$\frac{37}{32}$	$3\frac{15}{16}$	$\frac{21}{32}$	$1\frac{3}{4}$	$1\frac{1}{4}$
8	$1\frac{1}{2}$	9	$3\frac{1}{2}$	$7\frac{3}{8}$	$\frac{1}{4}$	$1\frac{1}{8}$	1	$1\frac{1}{4}$	$\frac{1}{2}$	$\frac{1}{8}$	$2\frac{3}{8}$	$\frac{15}{16}$	8	$4\frac{3}{4}$	$5\frac{1}{4}$	$3\frac{7}{8}$	$3\frac{11}{16}$	$4\frac{1}{2}$	$\frac{3}{4}$	2	$\frac{17}{16}$
12	$2\frac{1}{4}$	$13\frac{1}{2}$	$4\frac{7}{8}$	$11\frac{1}{16}$	$\frac{3}{8}$	$1\frac{11}{16}$	$1\frac{1}{2}$	$2\frac{5}{8}$	$\frac{3}{4}$	$\frac{3}{16}$	$3\frac{3}{32}$	$\frac{31}{32}$	12	$7\frac{1}{8}$	$7\frac{7}{8}$	$\frac{519}{16}$	$\frac{573}{32}$	$6\frac{3}{4}$	$\frac{1}{8}$	3	$2\frac{3}{32}$
18	$3\frac{3}{8}$	$20\frac{1}{4}$	$7\frac{5}{8}$	$16\frac{19}{32}$	$\frac{9}{16}$	$2\frac{17}{32}$	$2\frac{1}{4}$	$3\frac{15}{16}$	$1\frac{1}{8}$	$\frac{9}{32}$	$4\frac{15}{16}$	$2\frac{15}{16}$	18	$10\frac{11}{16}$	$11\frac{13}{16}$	$\frac{823}{64}$	$\frac{815}{16}$	$10\frac{1}{8}$	$\frac{1}{16}$	$4\frac{1}{2}$	$3\frac{1}{4}$

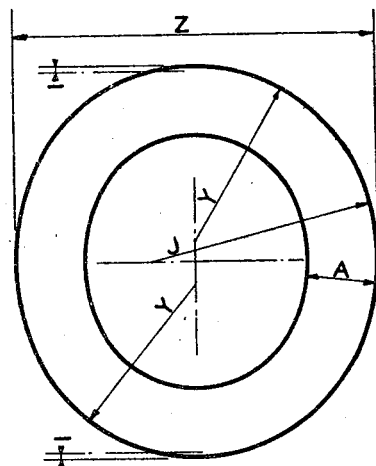
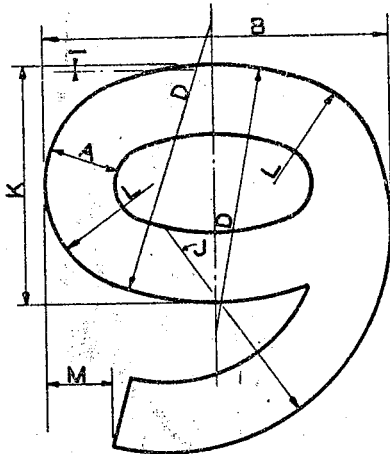
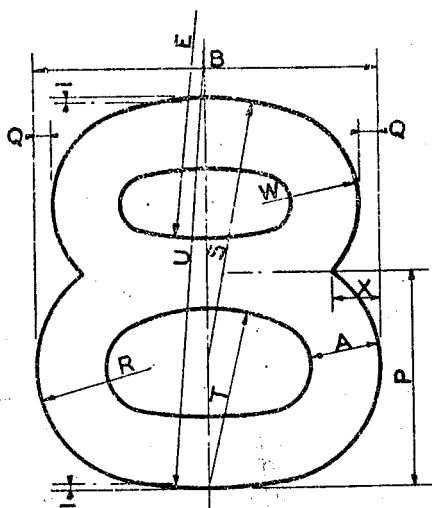
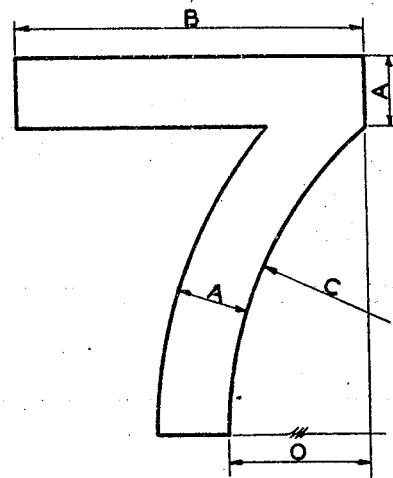
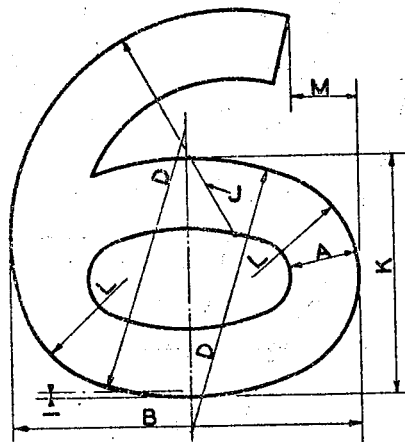
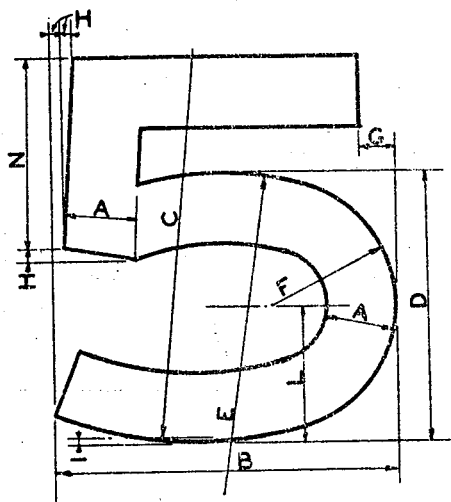

## SERIES F NUMERALS

HEIGHT (INCHES)	DIMENSIONS (INCHES)																									
	A	B	C	D	E	F	G	H	I	J	K	L	M	N	O	P	Q	R	S	T	U	V	W	X	Y	Z
2	$\frac{3}{8}$	$1\frac{17}{32}$	$2\frac{1}{16}$	$1\frac{7}{16}$	$1\frac{1}{2}$	$\frac{31}{32}$	$\frac{1}{16}$	$\frac{1}{16}$	$\frac{3}{32}$	$1\frac{1}{16}$	$1\frac{1}{4}$	$\frac{1}{16}$	$\frac{11}{32}$	1	$\frac{3}{4}$	$1\frac{1}{8}$	$\frac{3}{32}$	$\frac{13}{32}$	$1\frac{13}{32}$	$\frac{1}{8}$	$2\frac{3}{32}$	$\frac{31}{32}$	$\frac{1}{2}$	$\frac{1}{4}$	$\frac{31}{64}$	$1\frac{13}{32}$
3	$\frac{9}{16}$	$2\frac{29}{64}$	$3\frac{3}{32}$	$2\frac{5}{32}$	$2\frac{1}{4}$	$\frac{31}{32}$	$\frac{3}{32}$	$\frac{3}{32}$	$\frac{3}{16}$	$1\frac{3}{16}$	$1\frac{7}{8}$	$\frac{37}{32}$	$\frac{31}{32}$	$1\frac{1}{2}$	$1\frac{1}{8}$	$1\frac{1}{16}$	$\frac{3}{16}$	$\frac{57}{64}$	$2\frac{7}{64}$	$1\frac{13}{32}$	$3\frac{27}{64}$	$1\frac{5}{16}$	$\frac{3}{4}$	$\frac{3}{8}$	$1\frac{3}{8}$	$2\frac{31}{64}$
4	$\frac{3}{4}$	$3\frac{11}{16}$	$4\frac{1}{8}$	$2\frac{7}{8}$	3	$1\frac{1}{16}$	$\frac{3}{8}$	$\frac{1}{8}$	$\frac{1}{16}$	$2\frac{3}{8}$	$2\frac{1}{2}$	$1\frac{1}{8}$	$\frac{11}{16}$	2	$1\frac{1}{2}$	$2\frac{1}{4}$	$\frac{3}{16}$	$1\frac{1}{16}$	$2\frac{1}{16}$	$1\frac{7}{8}$	$4\frac{1}{16}$	$1\frac{7}{16}$	1	$\frac{1}{2}$	$1\frac{27}{32}$	$3\frac{1}{16}$
5	$1\frac{1}{8}$	$4\frac{39}{64}$	$5\frac{3}{32}$	$3\frac{19}{32}$	$3\frac{3}{4}$	$1\frac{11}{16}$	$\frac{13}{32}$	$\frac{3}{32}$	$\frac{5}{64}$	$2\frac{21}{32}$	$3\frac{1}{2}$	$1\frac{13}{32}$	$\frac{31}{32}$	$2\frac{1}{2}$	$1\frac{1}{8}$	$2\frac{1}{16}$	$\frac{13}{16}$	$1\frac{11}{16}$	$3\frac{1}{2}$	$2\frac{1}{32}$	$5\frac{27}{64}$	$1\frac{11}{16}$	$1\frac{1}{4}$	$\frac{5}{8}$	$2\frac{13}{16}$	$4\frac{31}{64}$
6	$1\frac{1}{2}$	$5\frac{17}{32}$	$6\frac{3}{16}$	$4\frac{5}{16}$	$4\frac{1}{2}$	$1\frac{31}{32}$	$\frac{9}{16}$	$\frac{3}{16}$	$\frac{3}{32}$	$3\frac{9}{16}$	$3\frac{3}{4}$	$1\frac{11}{16}$	$1\frac{13}{32}$	3	$2\frac{1}{4}$	$3\frac{3}{8}$	$\frac{3}{16}$	$1\frac{31}{32}$	$4\frac{7}{32}$	$2\frac{1}{16}$	$6\frac{27}{64}$	$2\frac{3}{32}$	$1\frac{1}{2}$	$\frac{3}{4}$	$2\frac{21}{32}$	$5\frac{27}{32}$
7	$1\frac{3}{8}$	$6\frac{23}{64}$	$7\frac{3}{32}$	$5\frac{1}{32}$	$5\frac{1}{4}$	$2\frac{19}{64}$	$\frac{31}{32}$	$\frac{7}{32}$	$\frac{7}{64}$	$4\frac{5}{32}$	$4\frac{3}{8}$	$1\frac{31}{32}$	$1\frac{13}{64}$	$3\frac{1}{2}$	$2\frac{5}{8}$	$3\frac{13}{16}$	$\frac{31}{64}$	$2\frac{5}{64}$	$4\frac{39}{64}$	$3\frac{3}{32}$	$7\frac{31}{64}$	$2\frac{23}{32}$	$1\frac{3}{4}$	$\frac{7}{8}$	$3\frac{7}{32}$	$6\frac{23}{64}$
8	$1\frac{1}{2}$	$7\frac{3}{8}$	$8\frac{1}{4}$	$5\frac{3}{4}$	6	$2\frac{3}{8}$	$\frac{3}{4}$	$\frac{1}{8}$	$4\frac{3}{4}$	5	$2\frac{1}{4}$	$1\frac{3}{8}$	4	3	$4\frac{1}{2}$	$\frac{3}{8}$	$2\frac{3}{8}$	$5\frac{5}{8}$	$3\frac{3}{4}$	9	$2\frac{7}{8}$	2	1	$3\frac{1}{16}$	$7\frac{3}{8}$	
12	$2\frac{1}{4}$	$11\frac{1}{16}$	$12\frac{3}{8}$	$8\frac{5}{8}$	9	$3\frac{1}{16}$	$1\frac{1}{8}$	$\frac{3}{8}$	$\frac{3}{16}$	$7\frac{1}{8}$	$7\frac{1}{2}$	$3\frac{3}{8}$	$2\frac{1}{16}$	6	$4\frac{1}{2}$	$6\frac{3}{4}$	$\frac{9}{16}$	$3\frac{1}{16}$	$8\frac{7}{16}$	$5\frac{5}{8}$	$13\frac{11}{16}$	$4\frac{1}{16}$	3	$1\frac{1}{2}$	$5\frac{17}{32}$	$11\frac{1}{16}$
18	$3\frac{3}{8}$	$16\frac{19}{32}$	$18\frac{3}{16}$	$12\frac{15}{16}$	$13\frac{1}{2}$	$5\frac{29}{32}$	$1\frac{11}{16}$	$\frac{9}{16}$	$\frac{9}{32}$	$10\frac{1}{16}$	$11\frac{1}{4}$	$5\frac{1}{16}$	$3\frac{3}{32}$	9	$6\frac{3}{4}$	$10\frac{1}{8}$	$\frac{27}{32}$	$5\frac{11}{32}$	$12\frac{21}{32}$	$8\frac{7}{16}$	$20\frac{17}{32}$	$6\frac{15}{32}$	$4\frac{1}{2}$	2	$8\frac{5}{16}$	$17\frac{5}{32}$